



OWNER'S MANUAL SMART 3D Blu-ray™ HOME THEATER SYSTEM

Please read this manual carefully before operating your set and retain it for future reference.

BH6730S (BH6730S, S63S2-S/ C, S63T1-W)

www.lg.com

Safety Information



CAUTION: TO REDUCE THE RISK OF ELECTRIC SHOCK DO NOT REMOVE COVER (OR BACK) NO USER-SERVICEABLE PARTS INSIDE REFER SERVICING TO QUALIFIED SERVICE PERSONNEL.



This lightning flash with arrowhead symbol within an equilateral triangle is intended to alert the user to the presence of uninsulated dangerous voltage within the product's

enclosure that may be of sufficient magnitude to constitute a risk of electric shock to persons.



The exclamation point within an equilateral triangle is intended to alert the user to the presence of important operating and maintenance (servicing)

instructions in the literature accompanying the product.

WARNING: This product contains chemicals known to the State of California to cause cancer and birth defects or other reproductive harm. ***Wash hands after handling.***

WARNING: TO PREVENT FIRE OR ELECTRIC SHOCK HAZARD, DO NOT EXPOSE THIS PRODUCT TO RAIN OR MOISTURE.

WARNING: Do not install this equipment in a confined space such as a book case or similar unit.

CAUTION: Do not block any ventilation openings. Install in accordance with the manufacturer's instructions.

Slots and openings in the cabinet are provided for ventilation and to ensure reliable operation of the product and to protect it from over heating. The openings shall be never be blocked by placing the product on a bed, sofa, rug or other similar surface. This product shall not be placed in a built-in installation such as a bookcase or rack unless proper ventilation is provided or the manufacturer's instruction has been adhered to.



CAUTION : CLASS 1M VISIBLE AND INVISIBLE LASER RADIATION WHEN OPEN. DO NOT VIEW DIRECTLY WITH OPTICAL INSTRUMENTS

Use of controls, adjustments or the performance of procedures other than those specified herein may result in hazardous radiation exposure.

CAUTION concerning the Power Cord

Most appliances recommend they be placed upon a dedicated circuit;

That is, a single outlet circuit which powers only that appliance and has no additional outlets or branch circuits. Check the specification page of this owner's manual to be certain. Do not overload wall outlets. Overloaded wall outlets, loose or damaged wall outlets, extension cords, frayed power cords, or damaged or cracked wire insulation are dangerous. Any of these conditions could result in electric shock or fire. Periodically examine the cord of your appliance, and if its appearance indicates damage or deterioration, unplug it, discontinue use of the appliance, and have the cord replaced with an exact replacement part by an authorized service center. Protect the power cord from physical or mechanical abuse, such as being twisted, kinked, pinched, closed in a door, or walked upon. Pay particular attention to plugs, wall outlets, and the point where the cord exits the appliance. To disconnect power from the mains, pull out the mains cord plug. When installing the product, ensure that the plug is easily accessible.

This device is equipped with a portable battery or accumulator.

Safety way to remove the battery or the battery from the equipment:

Remove the old battery or battery pack, follow the steps in reverse order than the assembly. To prevent contamination of the environment and bring on possible threat to human and animal health, the old battery or the battery put it in the appropriate container at designated collection points. Do not dispose of batteries or battery together with other waste. It is recommended that you use local, free reimbursement systems batteries and accumulators. The battery should not be exposed to excessive heat such as sunshine, fire or the like.

CAUTION: The apparatus shall not be exposed to water (dripping or splashing) and no objects filled with liquids, such as vases, shall be placed on the apparatus.

FCC Compliance Statement

This device complies with part 15 of the FCC rules.

Operation is subject to the following two conditions:

- (1) This device may not cause harmful interference, and
- (2) This device must accept any interference received, including interference that may cause undesired operation.

NOTE: This equipment has been tested and found to comply with the limits for a Class B digital device, pursuant to Part 15 of the FCC Rules. These limits are designed to provide reasonable protection against harmful interference in a residential installation. This equipment generates, uses, and can radiate radio frequency energy and, if not installed and used in accordance with the instructions, may cause harmful interference to radio communications. However, there is no guarantee that interference will not occur in a particular installation.

If this equipment does cause harmful interference to radio or television reception, which can be determined by turning the equipment off and on, the user is encouraged to try to correct the interference by one or more of the following measures:

- Reorient or relocate the receiving antenna.
- Increase the separation between the equipment and receiver.
- Connect the equipment into an outlet on a circuit different from that to
- which the receiver is connected.
- Consult the dealer or an experienced radio/TV technician for help.

CAUTION: Any changes or modifications not expressly approved by the party responsible for compliance could void the user's authority to operate this equipment

FCC RF Radiation Exposure Statement : This equipment complies with FCC radiation exposure limits set forth for an uncontrolled environment. This equipment should be installed and operated with minimum distance 20 cm between the radiator and your body. End users must follow the specific operating instructions for satisfying RF exposure compliance. This transmitter must not be co-located or operating in conjunction with any other antenna or transmitter.

FCC Radio Frequency Interference Requirements

This device is restricted to indoor use due to its operation in the 5.15 to 5.25 GHz frequency range. FCC requires this product to be used indoors for the frequency range 5.15 to 5.25 GHz to reduce the potential for harmful interference to co-channel Mobile Satellite systems. High power radars are allocated as primary users of the 5.25 to 5.35 GHz and 5.65 to 5.85 GHz bands. These radar stations can cause interference with and/or damage this device. This device cannot be co-located with any other transmitter.

CAUTION: Regulations of the FCC and FAA prohibit airborne operation of radio-frequency wireless devices because their signals could interfere with critical aircraft instruments.

Responsible Party :

LG Electronics USA, Inc. 1000 Sylvan Avenue
Englewood Cliffs, NJ 07632

TEL. : +1-800-243-0000

Notes on copyrights

- Because AACS (Advanced Access Content System) is approved as content protection system for Blu-ray Disc format, similar to use of CSS (Content Scramble System) for DVD format, certain restrictions are imposed on playback, analog signal output, etc., of AACS protected content. The operation of this product and restrictions on this product may vary depending on your time of purchase as those restrictions may be adopted and/or changed by AACS after the production of this product.
- Furthermore, BD-ROM Mark and BD+ are additionally used as content protection systems for Blu-ray Disc format, which imposes certain restrictions including playback restrictions for BD-ROM Mark and/or BD+ protected content. To obtain additional information on AACS, BD-ROM Mark, BD+, or this product, please contact an authorized Customer Service Center.
- Many BD-ROM/DVD discs are encoded with copy protection. Because of this, you should only connect your player directly to your TV, not to a VCR. Connecting to a VCR results in a distorted picture from copy-protected discs.
- This product incorporates copyright protection technology that is protected by U.S. patents and other intellectual property rights. Use of this copyright protection technology must be authorized by Rovi Corporation, and is intended for home and other limited viewing uses only unless otherwise authorized by Rovi Corporation. Reverse engineering or disassembly is prohibited.
- Under the U.S. Copyright laws and Copyright laws of other countries, unauthorized recording, use, display, distribution, or revision of television programs, videotapes, BD-ROM discs, DVDs, CDs and other materials may subject you to civil and/or criminal liability.

Caution

- Watching a 3D content for a long period time may cause dizziness or tiredness.
- It is not recommended to watch a movie in 3D mode for infirm, child and pregnant woman.
- If you are experiencing headache, tiredness or dizziness while viewing content in 3D, it is strongly recommended to stop the playback and rest until you feel normal.

IMPORTANT SAFETY INSTRUCTIONS

1. Read these instructions.
2. Keep these instructions.
3. Heed all warnings.
4. Follow all instructions.
5. Do not use this apparatus near water.
6. Clean only with dry cloth.
7. Do not block any ventilation openings. Install in accordance with the manufacturer's instructions.
8. Do not install near any heat sources such as radiators, heat registers, stoves, or other apparatus (including amplifiers) that produce heat.
9. Do not defeat the safety purpose of the polarized or grounding-type plug. A polarized plug has two blades with one wider than the other. A grounding type plug has two blades and a third grounding prong. The wide blade or the third prong are provided for your safety. If the provided plug does not fit into your outlet, consult an electrician for replacement of the obsolete outlet.
10. Protect the power cord from being walked on or pinched particularly at plugs, convenience receptacles, and the point where they exit from the apparatus.
11. Only use attachments/accessories specified by the manufacturer.
12. Use only with the cart, stand, tripod, bracket, or table specified by the manufacturer, or sold with the apparatus. When a cart is used, use caution when moving the cart/apparatus combination to avoid injury from tip-over. 
13. Unplug this apparatus during lightning storms or when unused for long periods of time.
14. Refer all servicing to qualified service personnel. Servicing is required when the apparatus has been damaged in any way, such as power-supply cord or plug is damaged, liquid has been spilled or objects have fallen into the apparatus, the apparatus has been exposed to rain or moisture, does not operate normally, or has been dropped.

Table of Contents

1 Getting Started

- 2 Safety Information
- 8 Introduction
- 8 – Playable discs and symbols used in this manual
- 9 – About the "Ⓞ" symbol display
- 9 – Regional code
- 10 Remote Control
- 11 Front Panel
- 11 Rear Panel

2 Connecting

- 12 Positioning the System
- 13 Speaker Connection
- 13 – Attaching the speakers to the player
- 14 Connecting to Your TV
- 15 – What is SIMPLINK?
- 15 – ARC (Audio Return Channel) function
- 16 – Resolution setting
- 17 Antenna Connection
- 17 Connections with External Device
- 17 – AUX connection
- 18 – PORT. IN connection
- 18 – OPTICAL IN connection
- 19 Connecting to Your Home Network
- 19 – Wired network connection
- 19 – Wired network setup
- 21 – Wireless network connection
- 21 – Wireless network setup

3 System Setting

- 24 Initial Setup
- 25 Settings
- 25 – Adjust the setup settings
- 26 – [NETWORK] menu
- 27 – [DISPLAY] menu
- 28 – [LANGUAGE] menu
- 29 – [AUDIO] menu
- 31 – [LOCK] menu
- 32 – [OTHERS] menu

- 33 Sound Effect

4 Operating

- 34 Home Menu Display
- 34 – Using [HOME] menu
- 34 – Using the Smart Share
- 35 Playing the Linked Devices
- 35 – Playing a disc
- 35 – Playing Blu-ray 3D disc
- 36 – Playing a file on disc/USB device
- 37 – Playing a file on a network server
- 38 Using Home Network Server for PC
- 38 – Installing Nero MediaHome 4 Essentials
- 38 – Sharing files and folders
- 39 – About Nero MediaHome 4 Essentials
- 39 – System requirements
- 40 General Playback
- 40 – Basic operations for video and audio content
- 40 – Basic operations for photo content
- 40 – Using the disc menu
- 41 – Resume playback
- 41 – Last scene memory
- 42 On-Screen Display
- 42 – To control video playback
- 42 – Displaying content information on-screen
- 44 Advanced Playback
- 44 – Repeat playback
- 44 – Repeating a specific portion
- 44 – Playing from selected time
- 45 – Selecting a subtitle language
- 45 – Hearing a different audio
- 45 – Watching from a different angle
- 45 – Changing the TV Aspect Ratio
- 46 – Changing Subtitle Code Page
- 46 – Changing the Picture Mode
- 46 – Viewing content information
- 47 – Changing content list view
- 47 – Selecting a subtitle file
- 48 – Listening to music during slide show
- 48 – Setting the [3D] option
- 49 Advanced Features
- 49 – Wi-Fi Direct™
- 50 – Enjoying BD-Live™

50	- LG AV Remote	65	Network Software Update
50	- Private Sound Mode	65	- Network update notification
51	- Viewing information from Gracenote Media Database	65	- Software update
52	- Audio CD recording	67	Additional Information
52	- Recording from FM radio or AUX/ PORTABLE source	67	- File requirement
53	Radio Operations	68	- AVCHD (Advanced Video Codec High Definition)
53	- Listening to the radio	69	- About DLNA
53	- Presetting the radio stations	69	- Certain system requirements
53	- Deleting a saved station	69	- Compatibility notes
53	- Deleting all the saved stations	70	Audio Output Specifications
53	- Improving poor FM reception	71	Area Code List
54	Playing the iPod	72	Language Code List
54	- Enjoying iPod on the screen	73	Trademarks and Licenses
54	- Enjoying the iPod IN mode	76	Specifications
56	Using Bluetooth technology	78	Maintenance
56	- Listening to music stored on the Bluetooth devices	78	- Handling the unit
58	Using the Premium	78	- Notes on discs
58	Using the LG Smart World	79	Important Information relating to Network Services
59	- Signing in		
59	- Searching online content		
60	Using the My Apps Menu		

5 Troubleshooting

61	Troubleshooting
61	- General
62	- Network
63	- Picture
63	- Sound
63	- Customer Support
63	- Open Source Software Notice













6 Appendix

64	Controlling a TV with the Supplied Remote Control
64	- Setting up the remote to control your TV

Some of the content in this manual may differ from your player depending on the software of the player or your service provider.

Introduction

Playable discs and symbols used in this manual

Media/Term	Logo	Symbol	Description
Blu-ray	  	BD	<ul style="list-style-type: none"> Discs such as movies that can be purchased or rented. "Blu-ray 3D" discs and "Blu-ray 3D ONLY" discs. BD-R/RE discs that are recorded in BDAV format.
		MOVIE MUSIC PHOTO	<ul style="list-style-type: none"> BD-R/RE discs that contain Video, Audio or Photo files. ISO 9660+JOLIET, UDF and UDF Bridge format
DVD-ROM DVD-R DVD-RW DVD+R DVD+RW (8 cm, 12 cm)	    	DVD	<ul style="list-style-type: none"> Discs such as movies that can be purchased or rented. Video mode and finalized only Supports the dual layer disc also
		AVCHD	Finalized AVCHD format
		MOVIE MUSIC PHOTO	<ul style="list-style-type: none"> DVD±R/RW discs that contain Video, Audio or Photo files. ISO 9660+JOLIET, UDF and UDF Bridge format
DVD-RW (VR) (8 cm, 12 cm)		DVD	VR mode and finalized only
Audio CD (8 cm, 12 cm)		ACD	Audio CD
CD-R/RW (8 cm, 12 cm)		MOVIE MUSIC PHOTO	<ul style="list-style-type: none"> CD-R/RW discs that contain Video, Audio or Photo files. ISO 9660+JOLIET, UDF and UDF Bridge format
Note	–		Indicates special notes and operating features.
Caution	–		Indicates cautions for preventing possible damages from abuse.

! Note

- Depending on the conditions of the recording equipment or the CD-R/RW (or DVD±R/RW) disc itself, some CD-R/RW (or DVD±R/RW) discs cannot be played on the unit.
- Depending on the recording software & the finalization, some recorded discs (CD-R/RW, DVD±R/RW, BD-R/RE) may not be playable.
- BD-R/RE, DVD±R/RW and CD-R/RW discs recorded using a personal computer or a DVD or CD Recorder may not play if the disc is damaged or dirty, or if there is dirt or condensation on the player's lens.
- If you record a disc using a personal computer, even if it is recorded in a compatible format, there are cases in which it may not play because of the settings of the application software used to create the disc. (Check with the software publisher for more detailed information.)
- This player requires discs and recordings to meet certain technical standards in order to achieve optimal playback quality.
- Pre-recorded DVDs are automatically set to these standards. There are many different types of recordable disc formats (including CD-R containing MP3 or WMA files) and these require certain pre-existing conditions to ensure compatible playback.
- Customers should note that permission is required in order to download MP3 / WMA files and audio from the Internet. Our company has no right to grant such permission. Permission should always be sought from the copyright owner.
- You have to set the disc format option to [Mastered] in order to make the discs compatible with the LG players when formatting rewritable discs. When setting the option to Live System, you cannot use it on LG player. (Mastered/Live File System : Disc format system for windows Vista)

About the "⓪" symbol display

"⓪" may appear on your TV display during operation and indicates that the function explained in this owner's manual is not available on that specific media.

Regional code

This unit has a regional code printed on the rear of the unit. This unit can play only BD-ROM or DVD discs labeled same as the rear of the unit or "ALL".

Remote Control

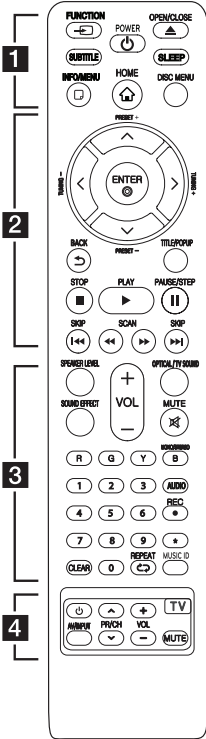

Battery Installation

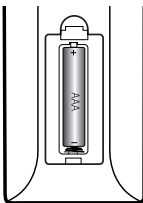

Remove the battery cover on the rear of the Remote Control, and insert R03 (size AAA) battery with **+** and **-** matched correctly.

..... **1**

FUNCTION: Changes input mode.

SUBTITLE: Selects a subtitle language.

POWER: Switches the player ON or OFF.

OPEN/CLOSE: Ejects a disc.

SLEEP: Sets a certain period of time after which the unit will switch to off.

INFO/MENU (□): Displays or exits On-Screen Display.

HOME (⤴): Displays or exits the [Home Menu].

DISC MENU: Accesses menu on a disc.

..... **2**

Direction buttons: Selects an option in the menu.

PRESET +/-: Selects programme of Radio.

TUNING +/-: Tunes in the desired radio station.

ENTER (⊙): Acknowledges menu selection.

BACK (↵): Exits the menu or returns to the previous screen.

TITLE/POPUP: Displays the DVD title menu or BD-ROM's pop-up menu, if available.

STOP (■): Stops playback.

PLAY (▶): Starts playback.

PAUSE/STEP (⏸): Pauses playback.

SKIP (⏮/⏭): Goes to the next or previous chapter / track / file.

SCAN (◀/▶): Searches backward or forward.

..... **3**

SPEAKER LEVEL: Sets the sound level of desired speaker.

SOUND EFFECT: Selects a sound effect mode.

VOL +/-: Adjusts speaker volume.

OPTICAL/ TV SOUND : Changes input mode to optical directly.

MUTE: Mute the unit.

Colored (R, G, Y, B) buttons:

- Use to navigate BD-ROM menus. They are also used as shortcut buttons for specific menus.

- B button: Selects mono/ stereo in FM mode.

0-9 numerical buttons: Selects numbered options in a menu.

CLEAR: Removes a mark on the search menu or a number when setting the password.

REPEAT (↺): Repeats a desired section or sequence.

MUSIC ID: When connected to the network, can provide information about the current song while movie playback.

AUDIO: Selects an audio language or audio channel.

REC: Records from an Audio CD, FM radio or AUX source to USB.

***:** Marked button is not available.

..... **4**

TV Control Buttons: See page 64.

Front Panel

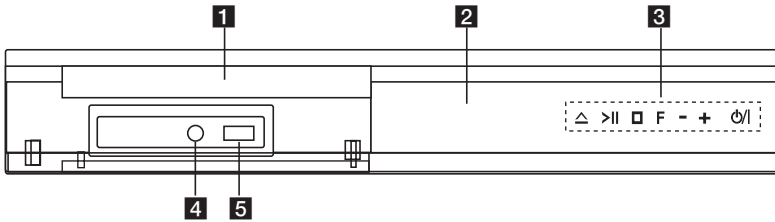

- | | |
|--|--|
| <p>1 Disc Tray</p> <p>2 Display Window</p> <p>3 Operation buttons
 △ (Open / Close)
 > (Play / Pause)
 □ (Stop)
 F (Function)
 Changes the input source or function.
 VOL -/+
 ⏻ / (Power)</p> | <p>4 PORT. IN</p> <p>5 USB (iPod/iPhone/iPad) Port</p> |
|--|--|

Rear Panel

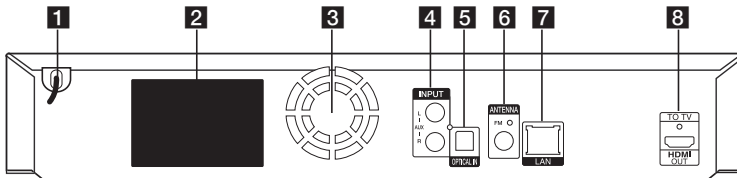

- | | |
|--|---|
| <p>1 AC power cord</p> <p>2 Speakers connectors</p> <p>3 Cooling Fan</p> <p>4 AUX (L/R) INPUT</p> <p>5 OPTICAL IN</p> <p>6 Antenna Connector</p> | <p>7 LAN port</p> <p>8 HDMI OUT TO TV</p> |
|--|---|

Positioning the System

The following illustration shows an example of positioning the system. Note that the illustrations in these instructions differ from the actual unit for explanation purposes.

For the best possible surround sound, all the speakers other than the subwoofer should be placed at the same distance from the listening position (A).

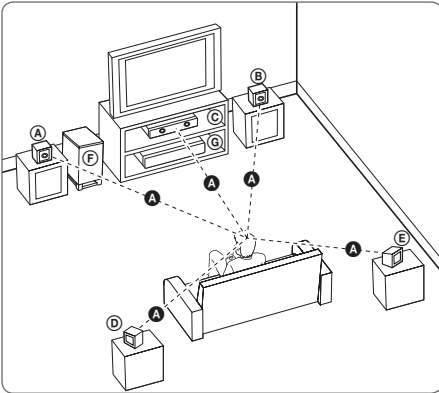

(A) Front left speaker (L)/

(B) Front right speaker (R):

Place the front speakers to the sides of the monitor or screen and as flush with the screen surface as possible.

(C) Center speaker:

Place the center speaker above or below the monitor or screen.

(D) Surround left speaker (L)/

(E) Surround right speaker (R):

Place these speakers behind your listening position, facing slightly inwards.

(F) Subwoofer:

The position of the subwoofer is not so critical, because low bass sounds are not highly directional. But it is better to place the subwoofer near the front speakers. Turn it slightly toward the center of the room to reduce the wall reflections.

(G) Unit

! Caution

- Be careful to make sure children not to put their hands or any objects into the *speaker duct.
*Speaker duct: A hole for plentiful bass sound on speaker cabinet (enclosure).
- Place the center speaker at a safe distance from the child's reach.
Otherwise it may result in the speaker falling down and causing personal injury and/or property damage.
- The speakers contain magnetic parts, so colour irregularity may occur on the CRT TV screen or PC monitor screen. Please use the speakers away from the TV screen or PC monitor screen.
- Before using the subwoofer, remove the protective vinyl.

Speaker Connection

Attaching the speakers to the player

1. Connect the wires to the unit.
Match each wire's colored band to the same colored connection terminal on the rear of the unit. To connect the cable to the unit, press each plastic finger pad to open the connection terminal. Insert the wire and release the finger pad.

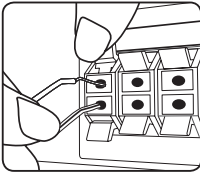

Connect the black stripe of each wire to the terminals marked - (minus) and the other end to the terminals marked + (plus).

Connect a woofer cord to the player. When connecting a woofer cord to the player, insert the connector until it clicks.

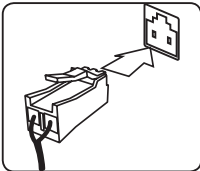

2. Connect the wires to the speakers.
Connect the other end of each wire to the correct speaker according to the color coding:

Color	Speaker	Position
Grey	Rear	Rear right
Blue	Rear	Rear left
Green	Center	Center
Orange	Sub woofer	Any front position
Red	Front	Front right
White	Front	Front left

To connect the cable to the speakers, press each plastic finger pad to open the connection terminals on the base of each speaker. Insert the wire and release the finger pad.

⚠ Caution

- Be careful to make sure children do not put their hands or any objects into the *speaker duct.
*Speaker duct : A hole for plentiful bass sound on speaker cabinet (enclosure).
- The speakers contain magnet parts, so color irregularity may occur on the TV screen or PC monitor screen. Please use the speakers far away from either TV screen or PC monitor.

Connecting to Your TV

If you have a HDMI TV or monitor, you can connect it to this player using a HDMI cable (Type A, High speed HDMI™ cable with Ethernet). Connect the HDMI jack on the player to the HDMI jack on a HDMI compatible TV or monitor.

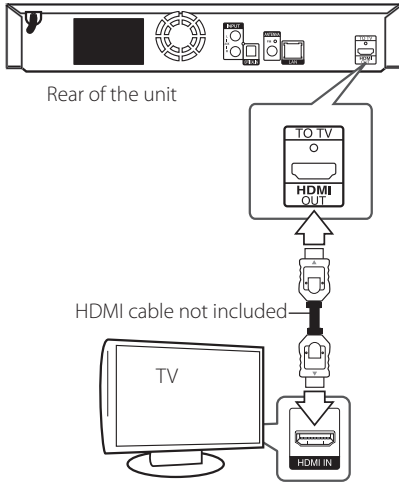

Set the TV's source to HDMI (refer to TV's Owner's manual).

Additional Information for HDMI

- When you connect a HDMI or DVI compatible device make sure of the following:
 - Try switching off the HDMI/DVI device and this player. Next, switch on the HDMI/DVI device and leave it for around 30 seconds, then switch on this player.
 - The connected device's video input is set correctly for this unit.
 - The connected device is compatible with 720x480p, 1280x720p, 1920x1080i or 1920x1080p video input.
- Not all HDCP-compatible HDMI or DVI devices will work with this player.
 - The picture will not be displayed properly with non-HDCP device.

! Note

- If a connected HDMI device does not accept the audio output of the player, the HDMI device's audio sound may be distorted or may not output.
- When you use HDMI connection, you can change the resolution for the HDMI output. (Refer to "Resolution setting" on page 16)
- Select the type of video output from the HDMI OUT jack using [HDMI Color Setting] option on the [Settings] menu (see page 28).
- Changing the resolution when the connection has already been established may result in malfunctions. To solve the problem, turn off the player and then turn it on again.
- When the HDMI connection with HDCP is not verified, TV screen is changed to black screen. In this case, check the HDMI connection, or disconnect the HDMI cable.
- If there are noises or lines on the screen, please check the HDMI cable (length is generally limited to 4.5 m(15 ft.)).

What is SIMPLINK?



Some functions of this unit are controlled by the TV's remote control when this unit and LG TV's with SIMPLINK are connected through HDMI connection.

Controllable functions by LG TV's remote control; Play, Pause, Scan, Skip, Stop, Power Off, etc.

Refer to the TV owner's manual for the details of SIMPLINK function.

LG TV's with SIMPLINK function has the logo as shown above.

Note

Depending on the disc type or playing status, some SIMPLINK operation may differ from your purpose or not work.

ARC (Audio Return Channel) function

The ARC function enables an HDMI capable TV to send the audio stream to HDMI OUT of this player.

To use this function:

- Your TV must support the HDMI-CEC and ARC function and the HDMI-CEC and ARC must be set to On.
- The setting method of HDMI-CEC and ARC may differ depending on the TV. For details about ARC function, refer to your TV manual.
- You must use the HDMI cable (Type A, High Speed HDMI™ cable with Ethernet).
- You must connect with the HDMI IN that supports the ARC function using the HDMI OUT on this player.
- You can connect only one Home Theater to TV compatible with ARC.

Note

To activate [SIMPLINK / ARC] function, set this option to [On]. (page 32)

Resolution setting

The player provides several output resolutions for HDMI OUT jack. You can change the resolution using [Settings] menu.

1. Press HOME (🏠).
2. Use </> to select the [Settings] and press ENTER (⊙). The [Settings] menu appears.
3. Use ^/v to select [DISPLAY] option then press > to move to the second level.
4. Use ^/v to select the [Resolution] option then press ENTER (⊙) to move to the third level.



5. Use ^/v to select the desired resolution then press ENTER (⊙) to confirm your selection.

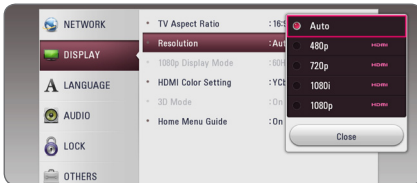

! Note

- If your TV does not accept the resolution you have set on the player, you can set resolution to 480p as follows:
 1. Press ▲ to open the disc tray.
 2. Press ■ (STOP) for more than 5 seconds.
- If you select a resolution manually and then connect the HDMI jack to TV and your TV does not accept it, the resolution setting is set to [Auto].
- If you select a resolution that your TV does not accept, the warning message will appear. After resolution change, if you cannot see the screen, please wait 20 seconds and the resolution will automatically revert back to the previous resolution.
- The 1080p video output frame rate may be automatically set to either 24 Hz or 60 Hz depending both on the capability and preference of the connected TV and based on the native video frame rate of the content on the BD-ROM disc.

Antenna Connection

Connect the supplied antenna for listening to the radio.

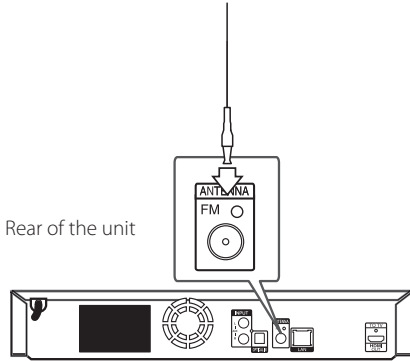

! Note

Be sure to fully extend the FM wire antenna.

Connections with External Device

AUX connection

You can enjoy the sound from an external component through the speakers of this system.

Connect the analog audio output jacks of your component into the AUX L/R (INPUT) on this unit. And then select the [AUX] option by pressing FUNCTION.

You can also use the F (Function) button on the front panel to select the input mode.

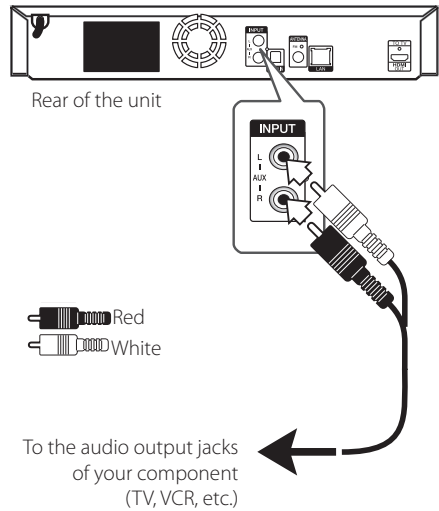

PORT. IN connection

You can enjoy the sound from your portable audio player through the speakers of this system.

Connect the headphones (or line out) jack of the portable audio player into the PORT. IN socket of this unit. And then select the [PORTABLE] option by pressing FUNCTION.

You can also use the F (Function) button on the front panel to select the input mode.

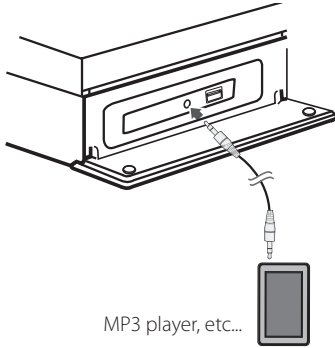

OPTICAL IN connection

You can enjoy the sound from your component with a digital optical connection through the speakers of this system.

Connect the optical output jack of your component into the OPTICAL IN jack on the unit. And then select the [OPTICAL] option by pressing FUNCTION. Or press OPTICAL / TV SOUND to select directly.

You can also use the F (Function) button on the front panel to select the input mode.

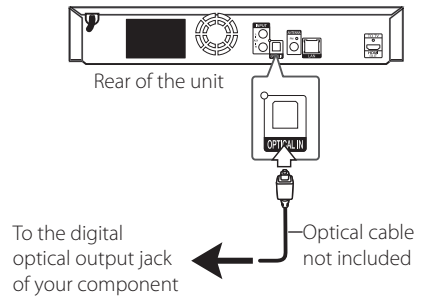

Connecting to Your Home Network

This player can be connected to a local area network (LAN) via the LAN port on the rear panel or the internal wireless module.

By connecting the unit to a broadband home network, you have access to services such as software updates, BD-Live interactivity and online content services.

Wired network connection

Using a wired network provides the best performance, because the attached devices connect directly to the network and are not subject to radio frequency interference.

Please refer to the documentation for your network device for further instructions.

Connect the player's LAN port to the corresponding port on your Modem or Router using a commercially available LAN or Ethernet cable.

! Note

- When plugging or unplugging the LAN cable, hold the plug portion of the cable. When unplugging, do not pull on the LAN cable but unplug while pressing down on the lock.
- Do not connect a modular phone cable to the LAN port.
- Since there are various connection configurations, please follow the specifications of your telecommunication carrier or internet service provider.
- If you want to access content from DLNA servers, this player must be connected to the same local area network with them via a router.
- To set your PC as a DLNA server, install the supplied Nero MediaHome 4 on your PC. (page 38)

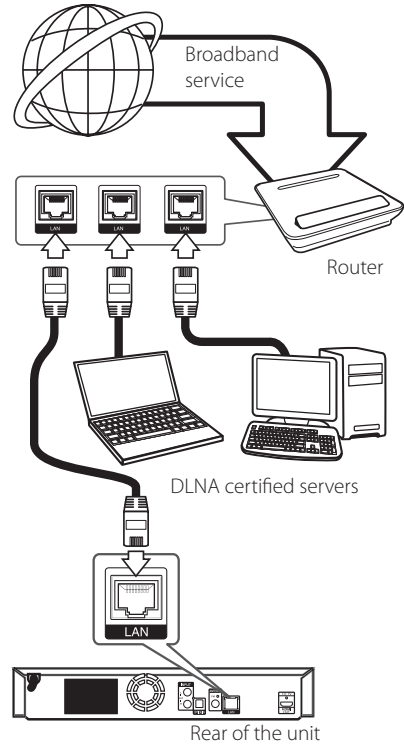

Wired network setup

If there is a DHCP server on the local area network (LAN) via wired connection, this player will automatically be allocated an IP address. After making the physical connection, a small number of home networks may require the player's network setting to be adjusted. Adjust the [NETWORK] setting as follow.

Preparation

Before setting the wired network, you need to connect the broadband internet to your home network.

1. Select [Connection Setting] option in the [Settings] menu then press ENTER (⊙).

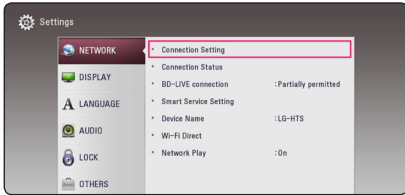

2. Read the preparations for the network settings and then press ENTER (⊙) while [Start] is highlighted.

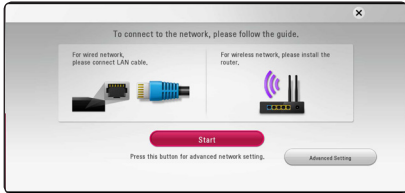

Network will automatically be connected to the unit.



Advanced Setting

If you want to set the network settings manually, use \wedge/\vee to select [Advanced Setting] on the [Network Setting] menu and press ENTER (⊙).

1. Use \wedge/\vee to select [Wired] and press ENTER (⊙).

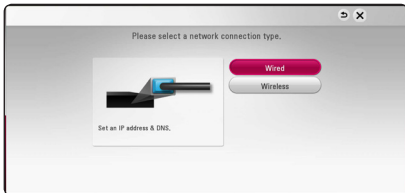

2. Use $\wedge/\vee/\lt;/\gt$ to select the IP mode between [Dynamic] and [Static]. Normally, select [Dynamic] to allocate an IP address automatically.

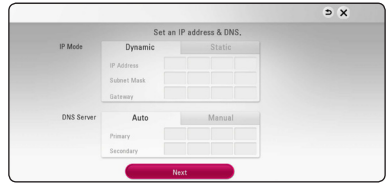

Note

If there is no DHCP server on the network and you want to set the IP address manually, select [Static] then set [IP Address], [Subnet Mask], [Gateway] and [DNS Server] using $\wedge/\vee/\lt;/\gt$ and numerical buttons. If you make a mistake while entering a number, press CLEAR to clear the highlighted part.

3. Select [Next] and press ENTER (⊙) to apply network settings.



Network connection status is displayed on the screen.

4. Press ENTER (⊙) while [OK] is highlighted to finish the wired network settings.

Wireless network connection

Another connection option is to use an Access Point or a wireless router. The network configuration and connection method may vary depending on the equipment in use and the network environment.

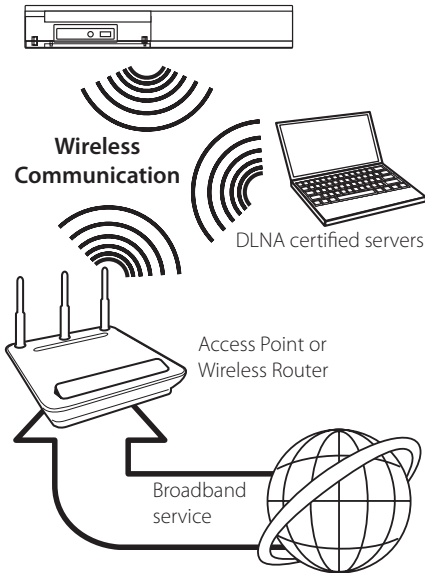

Refer to the setup instructions supplied with your access point or wireless router for detailed connection steps and network settings.

For best performance, a direct wired connection from this player to your home network's router or cable/DSL modem is always the best option. If you choose to use the wireless option, please note that performance can sometimes be affected by other electronic devices in the home.

Wireless network setup

For the wireless network connection, the player needs to be set up for network communication. This adjustment can be done from the [Settings] menu. Adjust the [NETWORK] setting as follow. Setting up the access point or the wireless router is required before connecting the player to the network.

Preparation

Before setting the wireless network, you need to:

- connect the broadband internet to the wireless home network.
- set the access point or wireless router.
- note the SSID and security code of the network.

1. Select [Connection Setting] option in the [Settings] menu then press ENTER (⊙).
2. Read the preparations for the network settings and then press ENTER (⊙) while [Start] is highlighted.

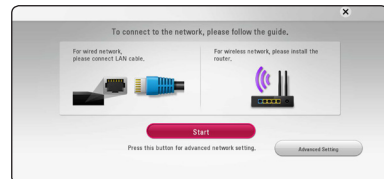

If wired network is not connected to the unit, all available networks are displayed on the screen.

3. Use \wedge / \vee to select a desired SSID of wireless network and press ENTER (⊙).



If you have security on your access point, you need to input the security code as necessary.

! Note

If you use other characters than the english alphabet or digits for the SSID name of your access point or wireless router, it may be displayed differently.

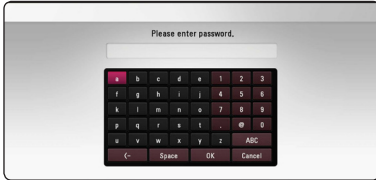

! Note

- WEP security mode generally have 4 keys available on an access point setting. If your access point or wireless router use WEP security, enter the security code of the key "No.1" to connect on your home network.
- An Access Point is a device that allows you to connect to your home network wirelessly.

4. Use $\wedge / \vee / < / >$ to select the IP mode between [Dynamic] and [Static]. Normally, select [Dynamic] to allocate an IP address automatically.

! Note

If there is no DHCP server on the network and you want to set the IP address manually, select [Static] then set [IP Address], [Subnet Mask], [Gateway] and [DNS Server] using $\wedge / \vee / < / >$ and numerical buttons. If you make a mistake while entering a number, press CLEAR to clear the highlighted part.

5. Select [Next] and press ENTER (⊙) to apply network settings.



Network connection status is displayed on the screen.

6. Select [OK] and press ENTER (⊙) to complete the network connection.

Advanced Setting

If you want to set the network settings manually, use \wedge / \vee to select [Advanced Setting] on the [Network Setting] menu and press ENTER (⊙).

1. Use \wedge / \vee to select [Wireless] and press ENTER (⊙).

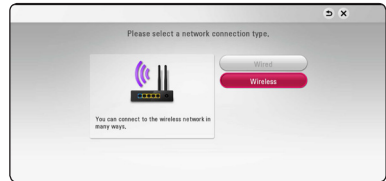

[AP List] - Scans all available access points or wireless routers within range and display them as a list.

[Network name (SSID)] - Your access point may not be broadcasting its network name (SSID). Check your access point settings through your computer and either set your access point to broadcast SSID, or manually enter the network name in [Network name(SSID)].

[PBC] - If your access point or wireless router that supports the PBC (Push Button Configuration) method, select this option and press the Push Button on your access point within 120 counts. You do not need to know the network name (SSID) and security code of your access point.

[PIN] - If your access point supports the PIN Code configuration method based on WPS (Wi-Fi Protected Setup), select this option and note the code number on the screen. And then, enter the PIN number on a setting menu of your access point to connect. Refer to the documentation for your network device.

2. Follow the instructions of each connection method on the screen.

! Note

To use PBC and PIN network connection, security mode of your access point must be set to OPEN or AES.

Notes on network connection

- Many network connection problems during set up can often be fixed by re-setting the router or modem. After connecting the player to the home network, quickly power off and/or disconnect the power cable of the home network router or cable modem. Then power on and/or connect the power cable again.
- Depending on the internet service provider (ISP), the number of devices that can receive internet service may be limited by the applicable terms of service. For details, contact your ISP.
- Our company is not responsible for any malfunction of the player and/or the internet connection feature due to communication errors/malfunctions associated with your broadband internet connection, or other connected equipment.
- The features of BD-ROM discs made available through the Internet Connection feature are not created or provided by our company, and our company is not responsible for their functionality or continued availability. Some disc related material available by the Internet Connection may not be compatible with this player. If you have questions about such content, please contact the producer of the disc.
- Some internet content may require a higher bandwidth connection.
- Even if the player is properly connected and configured, some internet content may not operate properly because of internet congestion, the quality or bandwidth of your internet service, or problems at the provider of the content.
- Some internet connection operations may not be possible due to certain restrictions set by the Internet service provider (ISP) supplying your broadband Internet connection.
- Any fees charged by an ISP including, without limitation, connection charges are your responsibility.
- A 10 Base-T or 100 Base-TX LAN port is required for wired connection to this player. If your internet service does not allow for such a connection, you will not be able to connect the player.
- You must use a Router to use xDSL service.
- A DSL modem is required to use DSL service and a cable modem is required to use cable modem service. Depending on the access method of and

subscriber agreement with your ISP, you may not be able to use the internet connection feature contained in this player or you may be limited to the number of devices you can connect at the same time. (If your ISP limits subscription to one device, this player may not be allowed to connect when a PC is already connected.)

- The use of a "Router" may not be allowed or its usage may be limited depending on the policies and restrictions of your ISP. For details, contact your ISP directly.
- The wireless network operate at 2.4 GHz radio frequencies that are also used by other household devices such as cordless telephone, *Bluetooth*® devices, microwave oven, and can be affected by interference from them.
- Turn off all unused network equipment in your local home network. Some devices may generate network traffic.
- For better reception, place the player from the access point as close as possible.
- In some instances, placing the access point or wireless router at least 0.45 m (1.5 ft.) above the floor may improve the reception.
- The reception quality over wireless depends on many factors such as type of the access point, distance between the player and access point, and the location of the player.
- Set your access point or wireless router to Infrastructure mode. Ad-hoc mode is not supported.

Initial Setup

When you turn on the unit for the first time, the initial setup wizard appears on the screen. Set the display language and network settings on the initial setup wizard.

1. Press **⏻** (POWER).
The initial setup wizard appears on the screen.
2. Use **▲/▼/◀/▶** to select a display language and press **ENTER** (⊙).



3. Read and prepare the preparations for the network settings and then press **ENTER** (⊙) while [Start] is highlighted.

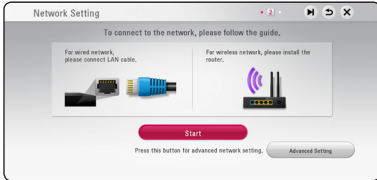

If wired network is connected, the network connection setting will automatically be finished.

4. All available networks are displayed on the screen. Use **▲/▼** to select [Wired Network] or desired SSID of wireless network and press **ENTER** (⊙).

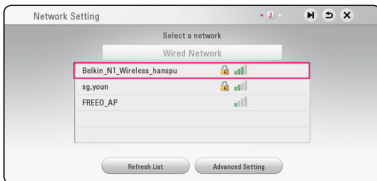

If you have security on your access point, you need to input the security code as necessary.

5. Use **▲/▼/◀/▶** to select the IP mode between [Dynamic] and [Static]. Normally, select [Dynamic] to allocate an IP address automatically.

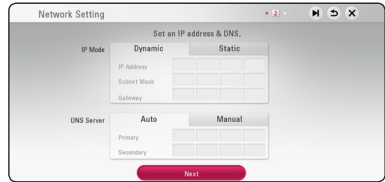

6. Select [Next] and press **ENTER** (⊙) to apply network settings.



Network connection status is displayed on the screen.

For details on network settings, refer to “Connecting to Your Home Network” on page 19.

7. Select [Next] and press ENTER (⊙).
8. Press ENTER (⊙) to verify the test tone signals of the speakers.

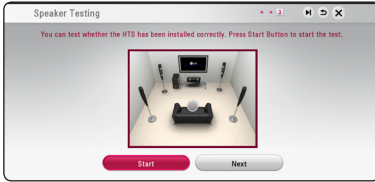

After verifying the test tone signals, press ENTER (⊙) while [Stop] is highlighted. Select [Next] and press ENTER (⊙).

9. You can listen to TV sound through HTS Speaker automatically when TV is turned on. TV and HTS should be connected with optical cable. Press **▲** to move and press **</>** to select [On] or [Off]. Select [Next] and press ENTER (⊙).



10. Check all the settings that you have set in the previous steps.

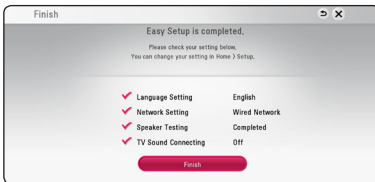

Press ENTER (⊙) while [Finish] is highlighted to finish the initial setup settings. If there is any settings to be changed, use **▲/▼/◀/▶** to select **▶** and press ENTER (⊙).

Settings

Adjust the setup settings

You can change the settings of the player in the [Settings] menu.

1. Press HOME (🏠).

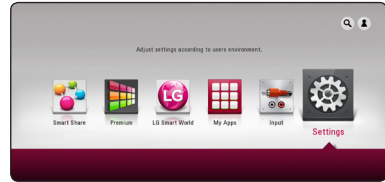

2. Use **</>** to select the [Settings] and press ENTER (⊙). The [Settings] menu appears.

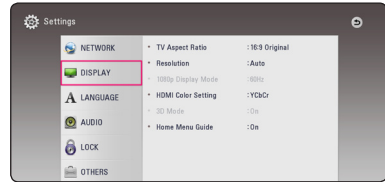

3. Use **▲/▼** to select the first setup option, and press **>** to move to the second level.

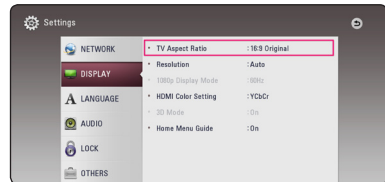

4. Use **▲/▼** to select a second setup option, and press ENTER (⊙) to move to the third level.

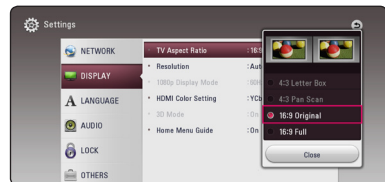

5. Use **▲/▼** to select a desired setting, and press ENTER (⊙) to confirm your selection.

[NETWORK] menu

The [NETWORK] settings are needed to use the software update, BD-Live and online content services.

Connection Setting

If your home network environment is ready to connect, the unit needs to be set up via wireless or wired connection for network communication. (See "Connecting to Your Home Network" on page 19.)

Connection Status

If you want to check the network status on this player, select the [Connection Status] options and press ENTER (⊙) to check whether a connection to the network and the internet have been established.

BD-LIVE connection

You can restrict Internet access when BD-Live functions are used.

[Permitted]

Internet access is permitted for all BD-Live content.

[Partially permitted]

Internet access is permitted only for BD-Live content which have content owner certificates. Internet access and AACIS Online functions are prohibited for all BD-Live content without a certificate.

[Prohibited]

Internet access is prohibited for all BD-Live content.

Smart Service Setting

[Country Setting]

Select your area for displaying proper online content service.

[Initialize]

- [Deactivate Netflix]
Deactivates your player. To activate the Netflix again, contact to the service provider.
 - [Netflix ESN]
Display its unique Netflix ESN (Electronic Serial Number) that allows you to use the Netflix streaming.
 - [Deactivate Vudu]
Deactivates your player. To activate the Vudu again, contact to the service provider.
-

Device Name

You can make a network name using virtual keyboard. This player will be recognised by the name you are entering on your home network.

Wi-Fi Direct

This player is a Wi-Fi Direct™ certified device. Wi-Fi Direct™ is the technology that enables devices to connect each other without connecting to an Access point or a router. Press ENTER (⊙) to display the Wi-Fi Direct menu. Refer to page 49 for the device connection.

Network Play

This function allows you to control the playback of media streamed from DLNA media server by a DLNA certified smartphone. Most DLNA certified smartphone has a function to control the playback media on your home network. Set this option to [On] for allowing your smartphone to control this unit. Refer to instructions of your DLNA certified smartphone or the application for more detailed information.

Note

- This unit and the DLNA Certified Smartphone must be connected to the same network.
- To use the [Network Play] function using a DLNA certified smartphone, press HOME (🏠) to display the home menu before connecting to this unit.
- While controlling the unit using the [Network Play] function, the remote control may not work.
- Available file formats described on page 67 are not always supported on [Network Play] function.

[DISPLAY] menu**TV Aspect Ratio**

Select a TV aspect ratio option according to your TV type.

[4:3 Letter Box]

Select when a standard 4:3 TV is connected. Displays theatrical images with masking bars above and below the picture.

[4:3 Pan Scan]

Select when a standard 4:3 TV is connected. Displays pictures cropped to fill your TV screen. Both sides of the picture are cut off.

[16:9 Original]

Select when a 16:9 wide TV is connected. The 4:3 picture is displayed with an original 4:3 aspect ratio, with black bars appearing at the left and right sides.

[16:9 Full]

Select when a 16:9 wide TV is connected. The 4:3 picture is adjusted horizontally (in a linear proportion) to fill the entire screen.

Note

You cannot select [4:3 Letter Box] and [4:3 Pan Scan] option when the resolution is set to higher than 720p.

Resolution

Sets the output resolution of the HDMI video signal. Refer to page 16 for details about the resolution setting.

[Auto]

If the HDMI OUT jack is connected to TVs providing display information (EDID), automatically selects the resolution best suited to the connected TV.

[480p]

Outputs 480 lines of progressive video.

[720p]

Outputs 720 lines of progressive video.

[1080i]

Outputs 1080 lines of interlaced video.

[1080p]

Outputs 1080 lines of progressive video.

1080p Display Mode

When the resolution is set to 1080p, select [24 Hz] for smooth presentation of film material (1080p/24 Hz) with a HDMI-equipped display compatible with 1080p/24 Hz input.

Note

- When you select [24 Hz], you may experience some picture disturbance when the video switches video and film material. In this case, select [60 Hz].
- Even when [1080p Display Mode] is set to [24 Hz], if your TV is not compatible with 1080p/24 Hz, the actual frame frequency of the video output will be 60 Hz to match the video source format.

HDMI Color Setting

Select the type of output from the HDMI OUT jack. For this setting, please refer to the manuals of your display device.

[YCbCr]

Select when connecting to a HDMI display device.

[RGB]

Select when connecting to a DVI display device.

3D Mode

Select the type of output mode for Blu-ray 3D disc playback.

[Off]

Blu-ray 3D disc playback will output as 2D mode like a normal BD-ROM disc playback.

[On]

Blu-ray 3D disc playback will output as 3D mode.

Home Menu Guide

This function allows you to display or delete the guide bubble on the [HOME] menu. Set this option to [On] for displaying guide.

[LANGUAGE] menu

Display Menu

Select a language for the [Settings] menu and on-screen display.

Disc Menu / Disc Audio / Disc Subtitle

Select the language you prefer for the audio track (disc audio), subtitles, and the disc menu.

[Original]

Refers to the original language in which the disc was recorded.

[Other]

Press ENTER (⏻) to select another language. Use number buttons then press ENTER (⏻) to enter the corresponding 4-digit number according to the language code list on page 72.

[Off] (Disc Subtitle only)

Turn off Subtitle.

! Note

Depending on the disc, your language setting may not work.

[AUDIO] menu

Each disc has a variety of audio output options. Set the player's Audio options according to the type of audio system you use.

! Note

Since many factors affect the type of audio output, see "Audio Output Specifications" on page 70 for details.

Digital Output

[PCM Stereo] (HDMI only)

Select if you connect this unit's HDMI OUT jack to a device with two-channel digital stereo decoder.

[PCM Multi-Ch] (HDMI only)

Select if you connect this unit's HDMI OUT jack to a device with multi-channel digital decoder.

[DTS Re-Encode] (HDMI only)

Select if you connect this unit's HDMI OUT jack to a device with DTS decoder.

[Bit Stream] (HDMI only)

Select if you connect this unit's HDMI OUT jack to a device with LPCM, Dolby Digital, Dolby Digital Plus, Dolby TrueHD, DTS and DTS-HD decoder.

! Note

- When [Digital Output] option is set to [PCM Multi-Ch], the audio may output as PCM Stereo if the PCM Multi-Ch information is not detected from HDMI device with EDID.
- If the [Digital Output] option is set to [DTS Re-Encode], the DTS Re-Encode audio is outputted for BD-ROM discs with secondary audio and the original audio is outputted for the other discs (like [Bit Stream]).
- This setting is not available on the input signal from an external device.

DRC (Dynamic Range Control)

This function allows you to listen to a movie at a lower volume without losing clarity of sound.

[Off]

Turns off this function.

[On]

Compress the dynamic range of the Dolby Digital, Dolby Digital Plus or Dolby TrueHD audio output.

[Auto]

The dynamic range of the Dolby TrueHD audio output is specified by itself.

And the dynamic range of the Dolby Digital and Dolby Digital Plus are operated as same as the [On] mode.

! Note

The DRC setting can be changed only when a disc is not inserted or the unit is in complete stop mode.

Speaker Setup

To obtain the best possible sound, use the speaker setup display to specify the volume of the speakers you have connected and their distance from your listening position. Use the test to adjust the volume of the speakers to the same level.

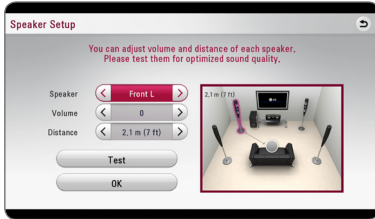

[Speaker]

Select a speaker that you want to adjust.

[Volume]

Adjust the output level of each speaker.

[Distance]

Adjust the distance between each speaker and the listening position.

[Test/ Stop test tone]

The speakers will emit a test tone.

[OK]

Confirms the setting.

HD AV Sync

Sometimes Digital TV encounters a delay between picture and sound. If this happens you can compensate by setting a delay on the sound so that it effectively 'waits' for the picture to arrive: this is called HD AV Sync. Use < > to scroll up and down through the delay amount, which you can set at anything between 0 and 300 ms.

[LOCK] menu

The [LOCK] settings affect only Blu-ray Disc and DVD playback.

To access the any features in [LOCK] settings, you must enter the 4-digit security code you have created.

If you have not entered a password yet, you are prompted to do so. Enter a 4-digit password twice, and press ENTER (Ⓞ) to create a new password.

Password

You can create or change the password.

[None]

Enter a 4-digit password twice, and press ENTER (Ⓞ) to create a new password.

[Change]

Enter the current password and press ENTER (Ⓞ). Enter a 4-digit password twice, and press ENTER (Ⓞ) to create a new password.

If you forget your password

If you forget your password, you can clear it using the following steps:

1. Remove any disc that might be in the player.
2. Select [Password] option in the [Settings] menu.
3. Use Number buttons to enter "210499". The password is cleared.

! Note

If you make a mistake before pressing ENTER (Ⓞ), press CLEAR. Then input the correct password.

DVD Rating

Blocks playback of rated DVD based on their content. (Not all discs are rated.)

[Rating 1-8]

Rating one (1) has the most restrictions and rating eight (8) is the least restrictive.

[Unlock]

If you select [Unlock], parental control is not active and the disc plays in full.

Blu-ray Disc Rating

Set an age limit of BD-ROM play. Use number buttons to input an age limit for BD-ROM viewing.

[255]

All BD-ROM can be played.

[0-254]

Prohibits play of BD-ROM with corresponding ratings recorded on them.

! Note

- The [Blu-ray Disc Rating] will be applied only for the Blu-ray disc that containing the Advanced Rating Control.
- For the region using MPAA rating level, refer to the table below as an example.

Blu-ray Disc Rating	MPAA Rating
0	G
8	PG
13	PG-13
17	R
18	NC-17
255	Not restricted

Area Code

Enter the code of the area whose standards were used to rate the DVD video disc, based on the list on page 71.

[OTHERS] menu

Auto Power Off

The screen saver appears when you leave the player in Stop mode for about 5 minutes. If you set this option to [On], the unit automatically turns off within 20 minutes since the Screen Saver is displayed. Set this option to [Off] to leave the screen saver until the unit is operated by the user.

! Note

When you set [Auto Power Off] function in setting menu on, this unit will be off itself to save electronic consumption in the case main unit is not connected to external device and is not used for 25 minutes.

So does this unit after six hours since Main unit has been connected to other device using analog input.

TV Sound Connecting

You can listen to TV sound through this unit's speaker automatically when TV is turned on. TV and this unit should be connected with optical cable.

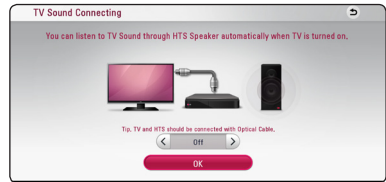

Press **▲** to move and press **</>** to select [On] or [Off]. Select [Next] and press ENTER (⊙).

Initialize

[Factory Set]

You can reset the player to its original factory settings.

[Blu-ray Storage Clear]

Initializes the BD-Live content from the connected USB storage.

! Note

If you reset the player to its original factory settings using [Factory Set] option, you have to set all the activation for the online services and network settings again.

Software

[Information]

Displays the current software version.

[Update]

You can update the software by connecting the unit directly to the software update server (page 65).

SIMPLINK/ARC

- The SIMPLINK function allows you to control this unit with LG TV's remote control.
- The ARC function enables an HDMI capable TV to send the audio stream to HDMI OUT of this player.

Set this option to [On] for activating [SIMPLINK / ARC] function. (page 15)

Sound Effect

You can select a suitable sound mode. Press SOUND EFFECT repeatedly until the desired mode appears on the front panel display or the TV screen. The displayed items for the equalizer maybe different depending on sound sources and effects.

[Natural Plus]: You can enjoy the natural sound effect same as 5.1 channel.

[Natural]: You can enjoy comfortable and natural sound.

[Bypass]: Software with multichannel surround audio signals is played according to the way it was recorded.

[Bass Blast]: Reinforce the bass sound effect from front left and right speaker and subwoofer.

[Loudness]: Improves bass and treble sound.

[User EQ]: You can adjust the sound by raising or lowering the level of specific frequency.

Setting the [User EQ]

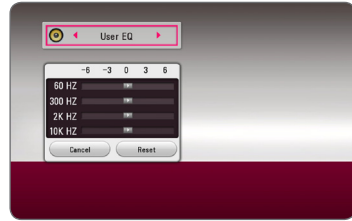

1. Use \wedge / \vee to select the desired frequency.
2. Use $< / >$ to select the desired level.

Select [Cancel] option then press ENTER (⊙) to cancel the setting.

Select [Reset] option then press ENTER (⊙) to reset the all adjustments.

Home Menu Display

Using [HOME] menu

The home menu appears when you press HOME (🏠). Use $\wedge / \vee / \langle / \rangle$ to select a category and press ENTER (⊙).



Note

Depending on the region, the [LG Smart World], [My Apps] service and [Search] function may not be available.

- 1** [Smart Share] - Displays Smart Share menu.
- 2** [Premium] - Displays the Premium home screen. (page 58)
- 3** [LG Smart World] - Displays LG Apps titles provided to the unit. (page 58)
- 4** [My Apps] - Displays the [My Apps] screen. (page 60)
- 5** [Input] - Changes input mode.
- 6** [Settings] - Adjusts the system settings.
- 7** [Search] - Searches for desired LG Apps and other content.
- 8** [Log In] - Displays login menu.

Using the Smart Share

You can play video, photo and audio content on the unit by inserting a disc, connecting an USB device or using home network (DLNA).

1. Press HOME (🏠) to display the home menu.
2. Select [Smart Share] and press ENTER (⊙).

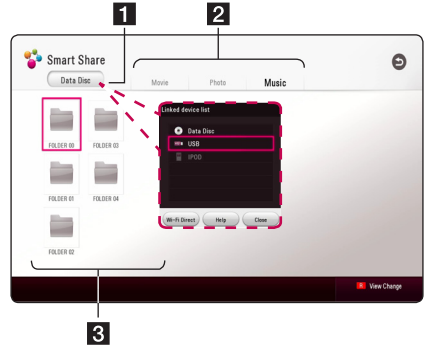

- 1** Displays all linked devices.
- 2** Displays video, photo or audio content.
- 3** Displays the file or folder on linked device.

Playing the Linked Devices

Playing a disc

BD DVD AVCHD ACD

1. Press ▲ (OPEN/CLOSE), and place a disc on the disc tray.
2. Press ▲ (OPEN/CLOSE) to close the disc tray.
For the most Audio CD, BD-ROM and DVD-ROM discs, playback starts automatically.
3. Press HOME (🏠) and then select [Smart Share].
4. Select disc icon.

! Note

- Playback functions described in this manual are not always available in every files and media. Some functions can be restricted depending on many factors.
- Depending on the BD-ROM titles, an USB device connection may be needed for the proper playback.
- Unfinalized DVD-VR format discs may not be played in this player.
- Some DVD-VR discs are made with CPRM data by DVD RECORDER. This unit cannot support these kinds of discs.

Playing Blu-ray 3D disc

BD

This player can play the Blu-ray 3D disc which contains separate views for the left and right eyes.

Preparation

In order to playback Blu-ray 3D title in stereoscopic 3D mode, you need to:

- Check your TV is 3D capable and has HDMI input(s).
- Wear 3D glasses to enjoy the 3D experience if it is necessary.
- Check whether the BD-ROM title is the Blu-ray 3D disc or not.
- Connect an HDMI cable (Type A, High Speed HDMI™ Cable) between the player's HDMI output and TV's HDMI input.

1. Press HOME (🏠), and set the [3D Mode] option on the [Settings] menu to [On] (page 28).
2. Press ▲ (OPEN/CLOSE), and place a disc on the disc tray.
3. Press ▲ (OPEN/CLOSE) to close the disc tray.
The playback starts automatically.
4. Refer to the owner's manual of your 3D-ready TV for the further instruction.

You may need to adjust the display settings and focus on your TV's setting for the improved 3D effect.

! Caution

- Watching a 3D content for a long period time may cause dizziness or tiredness.
- It is not recommended to watch a video in 3D mode for infirm, child and pregnant woman.
- If you are experiencing headache, tiredness or dizziness while viewing content in 3D, it is strongly recommended to stop the playback and rest until you feel normal.

Playing a file on disc/USB device

MOVIE MUSIC PHOTO

This player can play video, audio and photo files contained in the disc or USB device.

1. Insert a data disc on the tray or connect an USB device.

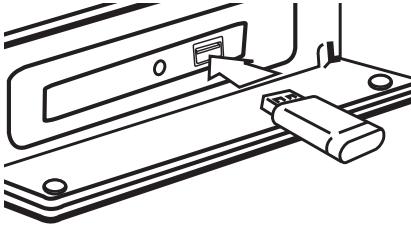

When you connect the USB device on the HOME menu, the player plays an audio file contained in the USB storage device automatically. If the USB storage device is containing various types of files, a menu for the file type selection will appear.

File loading may takes few minutes depending on the number of content stored in the USB storage device. Press ENTER (⊙) while [Cancel] is selected to stop loading.

2. Press HOME (🏠).
3. Select [Smart Share] and press ENTER (⊙).

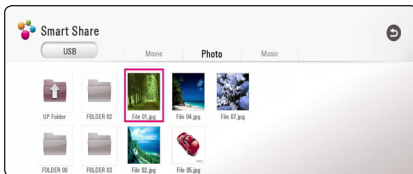

4. Select the desired linked device in the category.
5. Select [Movie], [Photo] or [Music].
6. Select a file using $\wedge / \vee / < / >$, and press \blacktriangleright (PLAY) or ENTER (⊙) to play the file.

Notes on USB device

- This player supports USB flash drive/external HDD formatted in FAT32 and NTFS when accessing files (music, photo, movie). However, for BD-Live, use the USB flash drive / external HDD formatted in FAT32.
- This unit can support up to 4 partitions of the USB device.
- Do not extract the USB device during operation (play, etc.).
- An USB device which requires additional program installation when you have connected it to a computer, is not supported.
- USB device: USB device that supports USB1.1 and USB2.0.
- Video, audio and photo files can be played. For details of operations on each file, refer to relevant pages.
- Regular back up is recommended to prevent data loss.
- If you use an USB extension cable, USB HUB or USB Multi-reader, the USB device may not be recognized.
- Some USB device may not work with this unit.
- Digital camera and mobile phone are not supported.
- USB Port of the unit cannot be connected to PC. The unit cannot be used as a storage device.

Playing a file on a network server

MOVIE MUSIC PHOTO

This player can play video, audio and photo files located in a DLNA server through your home network.

1. Check the network connection and settings (page 19).
2. Press HOME (🏠).
3. Select [Smart Share] and press ENTER (⊙).

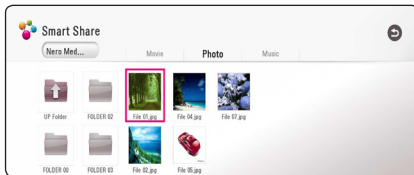

4. Select a DLNA media server in the category.
5. Select [Movie], [Photo] or [Music].
6. Select a file using \wedge / \vee / \lt / \gt , and press \blacktriangleright (PLAY) or ENTER (⊙) to play the file.

! Note

- The file requirements are described on page 67.
- Thumbnails of files with unsupported format will be displayed, but cannot be played on this unit.
- The subtitle file name and video file name have to be the same and located at the same folder.
- The playback and operating quality may be affected by your home network condition.
- You may experience connection problems depending on your server's environment.
- To set your PC as a DLNA server, install the supplied Nero MediaHome 4 on your PC. (page 38)

Using Home Network Server for PC

DLNA stands for Digital Living Network Alliance, which allows users to access video, photo and audio files stored in server and enjoy them on TV via home networking.

Before connecting to PC to play a file, Nero MediaHome 4 Essentials program should be installed on your PC.

Installing Nero MediaHome 4 Essentials

Windows

Start up your computer, and insert the supplied CD-ROM disc into your computer's CD-ROM drive. An installation wizard will walk you through the quick and uncomplicated installation process. To install Nero MediaHome 4 Essentials, proceed as follows:

1. Close all Microsoft Windows programs and exit any anti-virus software that may be running.
2. Insert the supplied CD-ROM disc into your computer's CD-ROM drive.
3. Click [Nero MediaHome 4 Essentials].
4. Click [Run] to start installation.
5. Click [Nero MediaHome 4 Essentials]. The installation is prepared and the installation wizard appears.
6. Click the [Next] button to display the serial number input screen. Click [Next] to go to the next step.
7. If you accept all conditions, click [I accept the License Conditions] check box and click [Next]. Installation is not possible without this agreement.
8. Click [Typical] and click [Next]. The installation process is started.
9. If you want to take part in the anonymous collection of data, select the check box and click the [Next] button.
10. Click the [Exit] button to complete the installation.

MAC OS X

1. Start up your computer, and insert the supplied CD-ROM disc into your computer's CD-ROM drive.
2. Browse the CD-ROM drive and open the "MediaHome_4_Essentials_MAC" folder.
3. Double-click the "Nero MediaHome.dmg" image file. The Nero MediaHome window is opened.
4. In the Nero MediaHome window, drag the Nero MediaHome icon either to the Applications folder within the window or to any other desired location.
5. You can now start the application by double-clicking the Nero MediaHome icon in the location you dragged it to.

Sharing files and folders

On your computer, you must share the folder containing video, audio and/or photo content to play them on this unit.

This part explains the procedure for selecting the shared folders on your computer.

1. Double-click the "Nero MediaHome 4 Essentials" icon.
2. Click [Network] icon on the left and define your network name in the [Network name] field. The Network name you enter will be recognized by your player.
3. Click [Shares] icon on the left.
4. Click [Local Folders] tab on the [Shares] screen.
5. Click [Add] icon to open the [Browse Folder] window.
6. Select the folder containing the files you want to share. The selected folder is added to the list of shared folders.
7. Click [Start Server] icon to start the server.

Note

- If the shared folders or files are not displayed on the player, click the folder on the [Local Folders] tab and click [Rescan Folder] at the [More] button.
- Visit www.nero.com for more information and software tools.

About Nero MediaHome 4 Essentials

Nero MediaHome 4 Essentials is a software for sharing video, audio and photo files stored on your computer to this unit as a DLNA-compatible digital media server.

Note

- The Nero MediaHome 4 Essentials CD-ROM is designed for PCs and should not be inserted in this player or in any product other than a PC.
- The supplied Nero MediaHome 4 Essentials CD-ROM is a customized software edition only for sharing files and folders to this player.
- The supplied Nero MediaHome 4 Essentials software does not support following functions: Transcoding, Remote UI, TV control, Internet services and Apple iTunes.
- The supplied Nero MediaHome 4 Essentials software can be downloaded at
 - Windows : <http://www.nero.com/download.php?id=nmhlgewin>
 - Mac OS : <http://www.nero.com/download.php?id=nmhlgemac>
- This manual explains operations with the English version of Nero MediaHome 4 Essentials as examples. Follow the explanation referring to the actual operations of your language version.

System requirements

Windows PC

- Windows® XP (Service Pack 2 or higher), Windows Vista® (no Service Pack required), Windows® 7 (no Service Pack required), Windows® XP Media Center Edition 2005 (Service Pack 2 or higher), Windows Server® 2003
- Windows Vista® 64-bit edition (application runs in 32-bit mode)
- Windows® 7 64-bit edition (application runs in 32-bit mode)
- Hard drive space: 200 MB hard drive space for a typical installation of Nero MediaHome stand-alone
- 1.2 GHz Intel® Pentium® III or AMD Sempron™ 2200+ processors
- Memory: 256 MB RAM
- Graphics card with at least 32 MB video memory, minimum resolution of 800 x 600 pixels, and 16-bit color settings
- Windows® Internet Explorer® 6.0 or higher
- DirectX® 9.0c revision 30 (August 2006) or higher
- Network environment: 100 Mb Ethernet, WLAN

Macintosh

- Mac OS X 10.5 (Leopard) or 10.6 (Snow Leopard)
- Macintosh computer with an Intel x86 processor
- Hard drive space: 200 MB hard drive space for a typical installation of Nero MediaHome stand-alone
- Memory: 256 MB RAM

General Playback

Basic operations for video and audio content

To stop playback

Press ■ (STOP) during playback.

To pause playback

Press || (PAUSE) during playback.

Press ► (PLAY) to resume playback.

To play frame-by-frame (Video)

Press || (PAUSE) during video playback.

Press || (PAUSE) repeatedly to play Frame-by-Frame playback.

To scan forward or backward

Press ◀◀ or ▶▶ to play fast forward or fast reverse during playback.

You can change the various playback speeds by pressing ◀◀ or ▶▶ repeatedly.

To slow down the playing speed

While the playback is paused, press ▶▶ repeatedly to play various speeds of slow motion.

To skip to the next/previous chapter/track/file

During playback, press ◀◀◀ or ▶▶▶ to go to the next chapter/track/file or to return to the beginning of the current chapter/track/file.

Press ◀◀◀ twice briefly to step back to the previous chapter/track/file.

In the file list menu of a server, there may have many types of content in a folder together. In this case, press ◀◀◀ or ▶▶▶ to go to the previous or next content with same type.

Basic operations for photo content

To play a slide show

Press ► (PLAY) to start slide show.

To stop a slide show

Press ■ (STOP) while slide show.

To pause a slide show

Press || (PAUSE) while slide show.

Press ► (PLAY) to re-start the slide show.

To skip to the next/previous photo

While viewing a photo in full screen, press < or > to go to the previous or next photo.

Using the disc menu

BD DVD AVCHD

To display the disc menu

The menu screen may be displayed first after loading a disc which contains a menu. If you want to display the disc menu during playback, press DISC MENU.

Use ^/√/</> buttons to navigate through menu items.

To display the Pop-up menu

Some BD-ROM discs contain Pop-up menu that appears during playback.

Press TITLE/POPOP during playback, and use ^/√/</> buttons to navigate through menu items.

Resume playback

BD DVD AVCHD MOVIE ACD
MUSIC

The unit records the point where you pressed the **■** (STOP) depending on the disc.

If “**||■** (Resume Stop)” appears on the screen briefly, press **▶** (PLAY) to resume playback (from the scene point).

If you press **■** (STOP) twice or unload the disc, “**■** (Complete Stop)” appears on the screen. The unit will clear the stopped point.

! Note

- The resume point may be cleared when a button is pressed (for example; **⏻** (POWER), **▲** (OPEN/CLOSE), etc).
- On BD-ROM discs with BD-J, the resume playback function does not work.
- If you press **■** (STOP) once during BD-ROM interactive title playback, the unit will be in Complete Stop mode.

Last scene memory

BD DVD

This unit memorizes the last scene from the last disc that is viewed. The last scene remains in memory even if you remove the disc from the unit or switch off the unit. If you load a disc that has the scene memorized, the scene is automatically recalled.

! Note

- Last Scene Memory function for a previous disc is erased once a different disc is played.
- This function may not work depending on the disc.
- On BD-ROM discs with BD-J, the last scene memory function does not work.
- This unit does not memorize settings of a disc if you switch off the unit before commencing to play it.

On-Screen Display

You can display and adjust various information and settings about the content.

To control video playback

BD DVD AVCHD MOVIE

You can control playback and set options while watching videos.

During playback, press INFO/MENU (□).

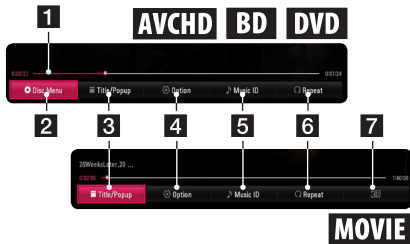

- 1 Progress bar** - Displays the current position and total playing time.
- 2 [Disc Menu]** - Accesses menu on a disc.
- 3 [Title/Popup]** - Displays the DVD title menu or BD-ROM's pop-up menu, if available.
- 4 [Option]** - Displays playback information.
- 5 [Music ID]** - When connected to the network, can provide information about the current song during video playback.
- 6 [Repeat]** - Repeats a desired section or sequence. (page 44)
- 7 [3D]** - Adjusts the 3D setting. (page 48)

Displaying content information on-screen

BD DVD AVCHD MOVIE

1. During playback, press INFO/MENU (□).
2. Select an [Option] using </>, and press ENTER (⊙).

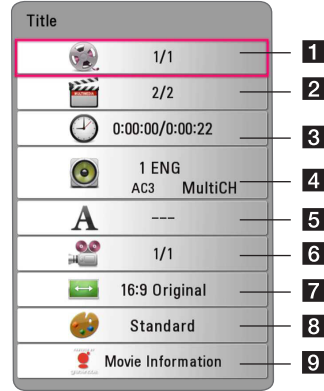

- 1 Title** – Current title number/total number of titles
- 2 Chapter** – Current chapter number/total number of chapters
- 3 Time** – Elapsed playing time/total playback time
- 4 Audio** – Selected audio language or channel
- 5 Subtitle** – Selected subtitle.
- 6 Angle** – Selected angle/total number of angles
- 7 TV Aspect Ratio** – Selected TV aspect ratio
- 8 Picture Mode** – Selected picture mode
- 9 Movie Information** – Select this option and press ENTER (⊙) to display movie information from Gracenote Media Database (BD-ROM/ DVD only).

Note

- If no button is pressed for a few seconds, the on-screen display disappears.
- A title number cannot be selected on some discs.
- Available items may differ depending on discs or titles.
- If an interactive Blu-ray Disc is playing back, some setting information is displayed on the screen but prohibited to be changed.
- To use the [Movie Information] option, the player must be connected to the broadband internet for accessing the Gracenote Media Database.
- LG is a license of Gracenote technology and is not responsible or liable for information from the Gracenote Media Database

To control photo view

Controls playback and sets options while viewing pictures in full screen.

You can control playback and set options while viewing pictures in full screen.

While viewing pictures, press INFO/MENU (□).



- 1 [Slideshow]** - Starts or pause slide show.
- 2 [Music]** - Select the background music for the slide show (page 48).
- 3 [Option]** - Displays slide show options.
- 4 [Rotate]** - Rotates the photo clockwise.
- 5 [Zoom]** - Displays the [Zoom] menu.

Setting the slide show option

You can use various options during viewing a photo in full screen.

1. While viewing pictures, press INFO/MENU (□).
2. Select an [Option] using </>, and press ENTER (⊙)

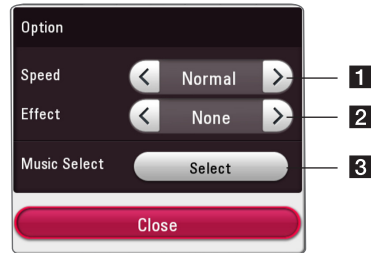

- 1 [Speed]** - Use </> to select a delaying speed between photos in a slide show.
- 2 [Effect]** - Use </> to select a transition effect between photos in a slide show.
- 3 [Music Select]** - Select the background music for the slide show (page 48).

Advanced Playback

Repeat playback

**BD DVD AVCHD ACD MUSIC
MOVIE**

Blu-ray Disc / DVD / Video files

During playback, press REPEAT (↺↻) to select a desired repeat mode.

A-B – Selected portion will be repeated continually.

Chapter – The current chapter will be played back repeatedly.

Title – The current title will be played back repeatedly.

All – All the titles or files will be played back repeatedly.

Off – Returns to normal playback.

To return to normal playback, press CLEAR.

Audio CDs/Audio files

During playback, press REPEAT (↺↻) repeatedly to select a desired repeat mode.

A-B – Selected portion will be repeated continually. (Audio CD only)

Track – The current track or file will be played back repeatedly.

All – All the tracks or files will be played back repeatedly.

All – All the tracks or files will be played back repeatedly in random order.

– The tracks or files will be played back in random order.

To return to normal playback, press CLEAR.

! Note

This function may not work on some disc or title.

Repeating a specific portion

BD DVD AVCHD ACD MOVIE

This player can repeat a portion you have selected.

1. During playback, press REPEAT (↺↻) to select [A-B] and press ENTER (⊙) at the beginning of the portion you wish to repeat.
2. Press ENTER (⊙) at the end of the portion. Your selected portion will be repeated continually.
3. To return to normal playback, press CLEAR.

! Note

- You cannot select a portion less than 3 seconds.
- This function may not work on some disc or title.

Playing from selected time

BD DVD AVCHD MOVIE

1. During playback, press INFO/MENU (□).
2. Select an [Option] using </>, and press ENTER (⊙).
3. Select the [Time] option and then input the required start time in hours, minutes, and seconds from left to right.
For example, to find a scene at 2 hours, 10 minutes, and 20 seconds, enter "21020".
Press </> to skip the playback 60 seconds forward or backward.
4. Press ENTER (⊙) to start playback from selected time.

! Note

- This function may not work on some disc or titles.
- This function may not work depending on the file type and ability of the DLNA server.

Selecting a subtitle language

BD DVD AVCHD MOVIE

1. During playback, press INFO/MENU (□).
2. Select an [Option] using </>, and press ENTER (⊙).
3. Use ^/∨ to select the [Subtitle] option.
4. Use </> to select desired subtitle language.
By pressing ENTER (⊙), you can set various subtitle options.
5. Press BACK (⏪) to exit the On-Screen display.

! Note

Some discs allow you to change subtitle selections only via the disc menu. If this is the case, press TITLE/POPOP or DISC MENU button and choose the appropriate subtitle from the selections on the disc menu.

Hearing a different audio

BD DVD AVCHD MOVIE

1. During playback, press INFO/MENU (□).
2. Select an [Option] using </>, and press ENTER (⊙).
3. Use ^/∨ to select the [Audio] option.
4. Use </> to select desired audio language, audio track or audio channel.

! Note

- Some discs allow you to change audio selections only via the disc menu. In this case, press TITLE/POPOP or DISC MENU button and choose the appropriate audio from the selections on the disc menu.
- Immediately after you have switched sound, there may be a temporary discrepancy between the display and actual sound.
- On BD-ROM disc, the multi audio format (5.1CH or 7.1CH) is displayed with [MultiCH] in the on-screen display.

Watching from a different angle

BD DVD

If the disc contains scenes recorded at different camera angles, you can change to a different camera angle during playback.

1. During playback, press INFO/MENU (□).
2. Select an [Option] using </>, and press ENTER (⊙).
3. Use ^/∨ to select the [Angle] option.
4. Use </> to select desired angle.
5. Press BACK (⏪) to exit the On-Screen display.

Changing the TV Aspect Ratio

BD AVCHD MOVIE

You can change the TV aspect ratio setting during playback.

1. During playback, press INFO/MENU (□).
2. Select an [Option] using </>, and press ENTER (⊙).
3. Use ^/∨ to select the [TV Aspect Ratio] option.
4. Use </> to select desired option.
5. Press BACK (⏪) to exit the On-Screen display.

! Note

Even if you change the value of the [TV Aspect Ratio] option in On-Screen display, the [TV Aspect Ratio] option in the [Settings] menu is not changed.

Changing Subtitle Code Page

MOVIE

If the subtitle is displayed in broken letter, you can change the subtitle code page to view the subtitle file properly.

1. During playback, press INFO/MENU (□).
2. Select an [Option] using </>, and press ENTER (⊙).
3. Use ^/∇ to select the [Code Page] option.
4. Use </> to select desired code option.

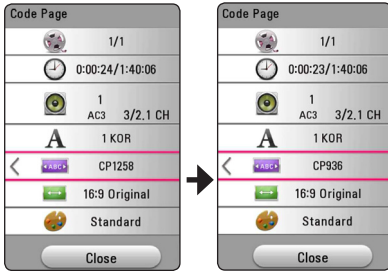

5. Press BACK (⏪) to exit the On-Screen display.

Changing the Picture Mode

BD DVD AVCHD MOVIE

You can change the [Picture mode] option during playback.

1. During playback, press INFO/MENU (□).
2. Select an [Option] using </>, and press ENTER (⊙).
3. Use ^/∇ to select the [Picture Mode] option.
4. Use </> to select desired option.
5. Press BACK (⏪) to exit the On-Screen display.

Setting the [User setting] option

1. During playback, press INFO/MENU (□).
2. Select an [Option] using </>, and press ENTER (⊙).
3. Use ^/∇ to select the [Picture Mode] option.
4. Use ^/∇ to select the [Picture Mode] option.
5. Use </> to select the [User setting] option, and press ENTER (⊙).

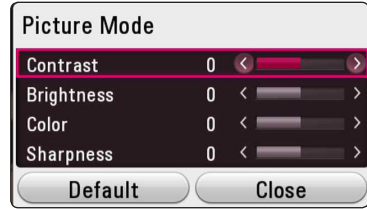

6. Use ^/∇/</> to adjust the [Picture Mode] options.

Select [Default] option then press ENTER (⊙) to reset the all video adjustments.

7. Use ^/∇/</> to select the [Close] option, and press ENTER (⊙) to finish setting.

Viewing content information

MOVIE

The player can display the content information.

1. Select a file using ^/∇/</>.
2. Press INFO/MENU (□) to display the option menu.

The file information appears on the screen.

During video playback, you can display the file information by pressing TITLE/POPUP.

! Note

The information displayed on the screen may not correct comparing actual content information.

Changing content list view

MOVIE MUSIC PHOTO

On the [Smart Share] menu, you can change the content list view.

Press red (R) colored button repeatedly.

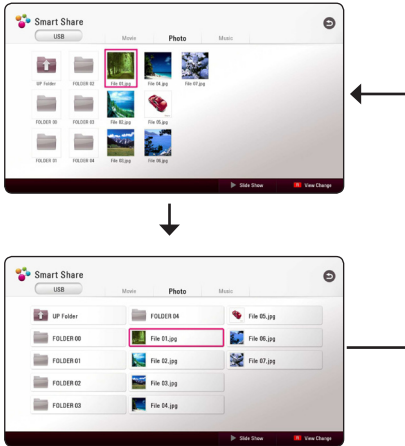

Selecting a subtitle file

MOVIE

If the subtitle file name is different from the video file name, you need to select the subtitle file on the [Movie] menu before playing the movie.

1. Use $\wedge / \vee / < / >$ to select the subtitle file you wish to play in the [Movie] menu.
2. Press ENTER (⊙).

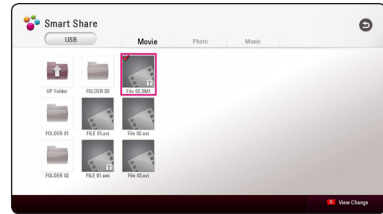

Press ENTER (⊙) again to deselect the subtitle file. Selected subtitle file will be displayed when you play the video file.

Note

- If you press ■ (STOP) during playback, the subtitle selection is cancelled.
- This function is not available for playing file on a server via home network.

Listening to music during slide show

PHOTO

You can display photo files while listening to audio files.

1. While viewing a photo in full screen, press INFO/MENU (□) to display the option menu.
2. Select an [Option] using </>, and press ENTER (⊙).
3. Use ^/∨ to select [Music Select] option, and press ENTER (⊙) to display the [Music Select] menu.
4. Use ^/∨ to select a device, and press ENTER (⊙).

Available device may differ depending on the location of the current photo file.

Photo location	Available Device
Disc, USB	Disc, USB
DLNA server	DLNA server

5. Use ^/∨ to select a file or a folder you wish to play.

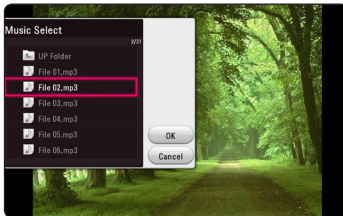

Select [UP Folder] and press ENTER (⊙) to display the upper directory.

! Note

When selecting audio file from a server, folder selection is not available. Only file selection is available.

6. Use > to select [OK], and press ENTER (⊙) to complete music selection.

Setting the [3D] option

MOVIE

This function allows you to play 3D content in case of file encoded in 3D.

1. During playback, press INFO/MENU (□).
2. Select [3D] using </>, and press ENTER (⊙).
3. Use ^/∨/</> to select desired options.

You can adjust 3D's depth and distance on the [3D Setting] option.

On [3D Setting], select [Init] option then press ENTER (⊙) to reset the all adjustments.

Advanced Features

Wi-Fi Direct™

Connecting to a Wi-Fi Direct™ certified device

MOVIE MUSIC PHOTO

This player can play movie, music and photo files located in a Wi-Fi Direct™ certified device. The Wi-Fi Direct™ technology make the player to be directly connected to a Wi-Fi Direct™ certified device without connecting to a network device such as an access point.

On Wi-Fi Direct™ certified device

1. Turn on the Wi-Fi Direct™ certified device and run its Wi-Fi Direct function.
2. Run DLNA application on the device.

On your player

3. Select [NETWORK] option in the [Settings] menu then press ENTER (⊙).
4. Select [Wi-Fi Direct] option, and press ENTER (⊙).

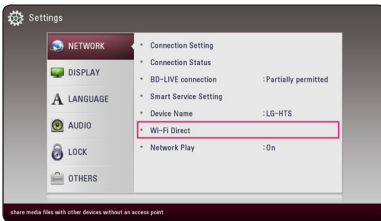

5. Select a Wi-Fi Direct™ device on the list using \wedge / \vee , and press ENTER (⊙).

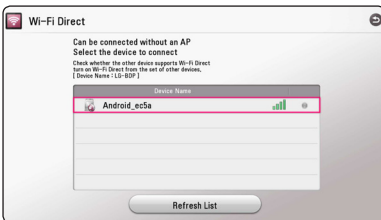

Wi-Fi Direct™ connection will be proceeded. follow the procedure on the screen.

If you want to rescan available Wi-Fi Direct™ devices, Select the [Refresh List] and press ENTER (⊙).

To select a server from the device list, files or folders must be shared by DLNA server from the connected Wi-Fi Direct™ device.

6. Select [Movie], [Photo] or [Music] using $\wedge / \vee / < / >$, and press ENTER (⊙).

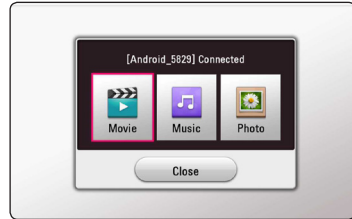

7. Select a file using $\wedge / \vee / < / >$, and press ENTER (⊙) to play the file.

! Note

- For the purpose of the better transmission, placing the player from the Wi-Fi Direct™ certified server as close as possible.
- This unit can connect only 1 device at a time. Multiple connection is not available.
- If you try to connect wireless network while a device is connected by Wi-Fi Direct™ function , Wi-Fi Direct™ connection will be force disconnected.
- If this player and a Wi-Fi Direct™ device are connected to the different local area network, Wi-Fi Direct™ connection may not available.
- If a Wi-Fi Direct™ certified device is not in Wi-Fi direct standby mode, this product cannot find the device.
- When you connect a Wi-Fi Direct™ certified device to your player, PIN network connection is not supported.
- This product cannot connect to a Wi-Fi direct™ device which is in Group Owner mode.

Enjoying BD-Live™

BD

BD-ROM supporting BD-Live that has a network extension function allows you to enjoy more functions such as downloading new movie trailers by connecting this unit to the internet.

1. Check the network connection and settings (page 19).
2. Insert an USB storage device to the USB port on the front panel.
An USB storage device is needed to download bonus content.
3. Press HOME (⏠), and set the [BD-LIVE connection] option on the [Settings] menu (page 26).

Depending on a disc, the BD-Live function may not be operated if [BD-LIVE connection] option is set to [Partially Permitted].

4. Insert a BD-ROM with BD-Live.

The operations may differ depending on the disc. Refer to the manual supplied with the disc.



Caution

Do not extract the connected USB device while content is being downloaded or a Blu-ray disc is still in the disc tray. Doing so may damage the connected USB device and BD-Live features may not operate properly with the damaged USB device anymore. If the connected USB device seems damaged from such an action, you can format the connected USB device from the PC and reuse it with this player.



Note

- Some BD-Live content may be restrictively accessed in some territories by content provider's own decision.
- It may take up to several minutes to load and start enjoying BD-Live content.
- For BD-Live, use the USB flash drive / external HDD formatted in FAT32 only.

LG AV Remote

You can control this player with your iPhone or Android phone via your home network. This player and your phone must be connected to your wireless network device such as access point. Visit "Apple iTunes" or "Google Android Market (Google Play Store)" for detailed information of "LG AV Remote".

Private Sound Mode

By downloading "LG AV Remote" application on your smart phone or tablet, you can connect your headsets, and enjoy the sound from your player on your smart devices.

This feature transmits video signal to TV through HDMI and audio signal to smart phone or tablet through Wi-Fi. For more detailed information, please refer to the Help menu on "LG AV Remote" application.

Viewing information from Gracenote Media Database

The player can access the Gracenote Media Database and load the music information so that Track name, Artist Name, Genre and other text information can be displayed on the list.

Audio CD

When you insert an Audio CD, the player starts playback automatically and loads the music title from the Gracenote Media Database.

If there is no music information from the database, music titles will not appear on the screen.

Music file

Select a music file using $\wedge/V/</>$ and press INFO/MENU (□) or MUSIC ID.

The player accesses to Gracenote Media Database for the music information.

Blu-ray Disc/DVD/Movie file

1. While listening to a music from the movie being played, press INFO/MENU (□).
2. Select a [Music ID] using $</>$, and press ENTER (⊙).

The player starts loading the music information from the Gracenote Media Database.

! Note

You can also start loading the music information directly by pressing MUSIC ID.

! Note

- The player must be connected to the broadband internet for accessing the Gracenote Media Database.
- If the music information is not in the Gracenote Media Database, message appears on the screen.
- Depending on the cases, it will takes a few minutes to load music information from the Gracenote Media Database.
- Information may be displayed in broken letters, if the language you selected is not available on the Gracenote Media Database.
- This function is not available for on-line content and content in DLNA servers.
- LG is a license of Gracenote technology and is not responsible or liable for information from the Gracenote Media Database.
- Audio CDs that users made for their only private purposes cannot be supported in this feature because they are not in the Gracenote Media Database.
- Supported music file extensions : mp3, wma, m4a, wav

Audio CD recording

You can record one desired track or all of the tracks in Audio CD to a USB storage device.

1. Insert a USB storage device to the USB port on the front panel.
2. Insert an Audio CD into the player.
The playback starts automatically.
3. Press (●) REC button to start [CD Recording].

	Stop mode	During playback
Recording track	All of the tracks	playing track
Recording time	4X speed	normal speed.

Recording from FM radio or AUX/ PORTABLE source

You can record from FM radio or AUX/ PORTABLE source to a USB storage device.

1. Insert a USB storage device to the USB port on the front panel.
2. In FM radio mode, tune to the desired radio station (See "Radio Operations" on page 53) or in AUX/ PORTABLE mode, start playback from the external source.
3. Press (●) REC button on the remote control.
 - The recording is saved as a file "EXT_REC" folder.

! Note

- For recording, use the USB flash drive / external HDD formatted in FAT32 only.
- Audio track is recorded to an audio file with 192 kbps. FM radio and AUX source are recorded to an audio file with 128 kbps.
- Audio CD recording times in the table above are approximate.
- Actual recording time for USB storage device varies depending on the USB storage device's ability.
- Make sure that there is minimum of 50 MB free space is needed when recording into the USB storage device.
- The length of the recording source should be longer than 20 seconds for the proper recording.
- Do not turn off this player or extract the connected USB storage device during the recording.

! Caution

The recording or copying features on this player are provided for your personal and non-commercial use. The making of unauthorized copies of copy-protected material, including computer programs, files, broadcasts and sound recordings, may be an infringement of copyrights and constitute a criminal offense. This equipment should not be used for such purposes. LG expressly disclaims any responsibility for illegal distribution or use of unauthorized content in commercial purpose.

Be Responsible
Respect Copyrights

Radio Operations

Be sure that the antennas are connected.
(Refer to the page 17)

Listening to the radio

1. Press FUNCTION until TUNER (FM) appears in the display window. The last received station is tuned in.
2. Press and hold TUNING (-/+) for about two seconds until the frequency indication starts to change. Scanning stops when the unit tunes in a station. Or Press TUNING (-/+) repeatedly.
3. Adjust the volume by pressing VOL (+/-).

Presetting the radio stations

You can preset 50 stations for FM.
Before tuning, make sure that you have turned down the volume.

1. Press FUNCTION until the TUNER (FM) appears in the display window.
2. Select the desired frequency by using TUNING (-/+).
3. Press ENTER (⊙) a preset number will flash in the display window.
4. Press PRESET (-/+) to select the preset number you want.
5. Press ENTER (⊙). The station is stored.
6. Repeat the steps 2 to 5 to store other stations.

Deleting a saved station

1. Press PRESET (- / +) to select a preset number you want to delete.
2. Press CLEAR, the preset number will blink in the display window.
3. Press CLEAR again, to delete the selected preset number.

Deleting all the saved stations

Press and hold CLEAR for two seconds.
"ERASE ALL" will flash up. Press CLEAR again. Then all the saved stations are deleted.

Improving poor FM reception

Press B (blue) (MONO/STEREO) colored button on the remote control. This will change the tuner from stereo to mono and usually improve the reception.

Playing the iPod

You can enjoy the sound with your iPod. For details about iPod, refer to the iPod's User Guide.

Preparation

Before connecting the iPod, turn this unit off and reduce the volume of this unit to its minimum.

! Note

Use the iPod cable supplied with your iPod.

1. Connect the iPod to the USB port on the front panel.
If you turn this unit on, your iPod is automatically turned on and recharging starts. When you connect the iPod on the HOME menu, the player plays a music automatically.
2. Select a file using $\wedge / \vee / < / >$, and press ENTER (⊙) to play the file.

Enjoying iPod on the screen

1. Connect the iPod to the USB port on the front panel.
2. Press HOME (⏏).
3. Select [Smart Share] using $< / >$, and press ENTER (⊙).
If a disc is already inserted, select the iPod on the menu.
4. Select a file using $\wedge / \vee / < / >$, and press ENTER (⊙) to play.

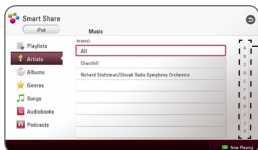

Power scroll

You can search easily a content by power scroll on the screen.

Select a power scroll using $>$ and select the initial of the desired content.

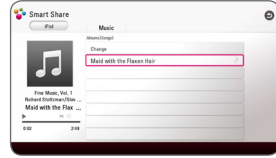

Press REPEAT (⏮) to select a desired repeat mode :Track (🔁), All (🔁), Shuffle All (🔁), Shuffle (🔁), Off (No display)

! Note

If the iPod's OSD language is selected to simple chinese, the power scroll function is not operated correctly.

Enjoying the iPod IN mode

You can operate your iPod by using the supplied remote control and controls on your iPod.

1. Connect the iPod to the USB port on the front panel.
If you turn this unit on, your iPod is automatically turned on and recharging starts.
2. Press FUNCTION to select iPod in mode.

$\wedge / \vee / < / >$	Selects an option in the menu.
ENTER (⊙)	Starts playback the music.
⏸ or ▶ (PLAY)	To pause while it is playing. To resume playing, press ⏸ or ▶ (PLAY) again.
(Press and hold) ⏩ / ⏪	Fast-forward or rewind a song
⏩ / ⏪	Skip the playback forward or backward .

! Note

- An error message “CHECK” or “Connected iPod model is not supported.” appears when:
 - your iPod is not available for the function to be operated.
- An error message “CHECK” or “Please update your iPod’s software.” appears when:
 - your iPod has an old software version.
 - ➔ Update your iPod software to latest version.
- If this unit displays an error message, follow the message. An error message “CHECK” or “Please check your iPod.” appears when:
 - the communication between this unit and your iPod is failed.
 - ➔ Connect & reconnect your iPod in this unit.
 - your iPod is not connected firmly.
 - this unit recognises your iPod as unknown device.
- Your iPod is exceptionally low on power.
 - ➔ The battery needs to be charged.
 - ➔ If you charge the battery while iPod is extremely low in power, it may take longer to charge.
- Compatibility with your iPod may vary depending on the type of your iPod.
- iPod touch, iPhone and iPad have any difference in operation other than iPod. You may need any additional control to use them with this unit. (e.g. “slide to unlock”)
- If you use an application, make a call, or send and receive SMS text message, etc. on iPod touch, iPhone or iPad, disconnect it from to the USB port of this unit and then use it.
- Depending on your iPod’s software version, it may not be possible to control your iPod from this unit. We recommend installing the latest software version.
- This unit supports the models as follows.
 - iPad mini
 - iPad nano 4G, 5G, 6G
 - iPod touch 1G, 3G, 4G, 5G, 7G
 - iPhone 3G, 3GS, 4, 4S, 5
 - iPad, iPad2, New iPad, iPad4
- If you have a problem with your iPod, please visit www.apple.com/support/ipod.

Using Bluetooth technology

About Bluetooth

Bluetooth® is wireless communication technology for short range connection.

The available range is within 10 meters.

(The sound may be interrupted when the connection interfered by the other electronic wave or you connect the bluetooth in the other rooms.)

Connecting individual devices under *Bluetooth®* wireless technology does not incur any charges. A mobile phone with

Bluetooth® wireless technology can be operated via the Cascade if the connection was made via *Bluetooth®* wireless technology.

Available Devices : Mobile phone, MP3, Laptop, PDA (This units be supported the Stereo Headset.)

Bluetooth Profiles

In order to use Bluetooth wireless technology, devices must be able to interpret certain profiles.

This unit is compatible with following profile.

A2DP (Advanced Audio Distribution Profile)

Listening to music stored on the Bluetooth devices

Pairing your unit and Bluetooth device

Before you start the pairing procedure, make sure the Bluetooth feature is turned on in to your Bluetooth device. Refer to your Bluetooth device's user guide. Once a pairing operation is performed, it does not need to be performed again.

1. Select the Bluetooth function by using the **FUNCTION**.
Appears "BT READY" in display window.
2. Operate the Bluetooth device and perform the pairing operation. When searching for this unit with the Bluetooth device, a list of the devices found may appear in the Bluetooth device display depending on the type of Bluetooth device. Your unit appears as "LG HTS".
3. When this unit successfully paired with your Bluetooth device, Bluetooth LED of this unit lights up and "BTPAIRED" appears in the display window.

! Note

Depending on the Bluetooth device type, some device have a different pairing way.

4. Listen to music.
To play a music stored on your Bluetooth device, refer to your Bluetooth device's user guide.

! Note

If you change the function of the unit, the Bluetooth function is disconnected, operate pairing again.

Note

- The sound may be interrupted when the connection interfered by the other electronic wave.
- You cannot control the Bluetooth device with this unit.
- Pairing is limited one Bluetooth device per one unit and multi-pairing is not supported.
- Although the distance between your Bluetooth and the set is less than 10m, there are obstacles between both, your Bluetooth device cannot be connected.
- Depending on the type of the device, you may not be able to use the Bluetooth function.
- When not connected the Bluetooth, "BT READY" appears on the display window.
- The Electrical malfunction due to devices using same frequency such as Medical equipment, Microwaves or wireless LAN devices, the connection will be disconnected.
- When someone stands and interrupts communication between Bluetooth device and the player, the connection will be disconnected.
- If the gotten away of the distance between Bluetooth and the unit, the sound quality is lower and lower the connection will disconnect when the space between the Bluetooth and the unit gets out of the operating range of Bluetooth.
- The device with Bluetooth wireless technology is disconnected, if you turn off the main unit or put the device away from the main unit more than 10m.

Using the Premium

You can use various content services via Internet with the Premium feature.

1. Check the network connection and settings (page 19).
2. Press HOME (🏠).
3. Select the [Premium] using \langle / \rangle , and press ENTER (⊙).

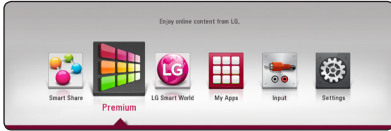

4. Select an online service using $\wedge / \vee / \langle / \rangle$, and press ENTER (⊙).

! Note

- For detailed information of each service, contact to the content provider or visit support link of the service.
- The content of Premium services and service related information, including user interface, is subject to changes. Please refer to the web site of each service for most up-to-date information.
- Using Premium features with wireless network connection may result in improper streaming speed by interference from household devices that are using radio frequencies.
- For the first time to access [Premium] or [LG Smart World] feature, current country setting appears. If you want to change the country setting, select [Edit] and press ENTER (⊙).

Using the LG Smart World

You can use the LG application services on this player via Internet. You can easily find and download various applications from LG Smart World.

1. Check the network connection and settings (page 19).
2. Press HOME (🏠).
3. Select the [LG Smart World], and press ENTER (⊙).



4. Select a category using \langle / \rangle , and press ENTER (⊙).
5. Use $\wedge / \vee / \langle / \rangle$ to select an application, and press ENTER (⊙) to display the information.
6. Press ENTER (⊙) while [Install] icon is highlighted. The application will be installed to the player.

To install an application to the player, user needs to sign in. Refer to page 59 for more information of signing in.

7. Press yellow (Y) colored button to display the [My Apps] screen.
8. Select the installed application and press ENTER (⊙) to execute it.

! Note

- Depending on the region, the [LG Smart World], [My Apps] service and [Search] function may not be available.
- To install a paid application, you need to be a paid member. Visit www.lgappstv.com for more information.

Signing in

To use the [LG Smart World] feature, you need to sign in with your account.

1. On the [LG Smart World] or [My Apps] screen, press red (R) colored button.
2. Fill the [ID] and [Password] field using the virtual keyboard.

If you do not have an account, press red (R) colored button to register.

3. Use $\wedge / \vee / \langle / \rangle$ to select [OK], and press ENTER (⊙) to sign in with your account.

If you select the [Auto Sign In] check box, your ID and password are remembered and automatically signed in without entering them.

! Note

- If you want to sign in with other account, press red (R) colored button on [LG Smart World] or [My Apps] screen, and select [Change User] option.
- To view the information of your account and applications, press red (R) colored button on [LG Apps] or [My Apps] screen, and select [Account Setting] option.

Searching online content

If you are having difficulties finding specific content from online services, you can use the all-in-one search function by entering keywords in the [Search] menu.

1. Press HOME (⬇️).
2. Select the [Search] icon on the home menu using $\wedge / \vee / \langle / \rangle$, and press ENTER (⊙).

The [Search] menu appears on the screen with virtual keyboard.

3. Use $\wedge / \vee / \langle / \rangle$ to select letters then press ENTER (⊙) to confirm your selection on the virtual keyboard.
4. When you finish entering the keyword, select [OK] and press ENTER (⊙) to display search result.
5. Use $\wedge / \vee / \langle / \rangle$ to select a desired content, and press ENTER (⊙) to move to the selected content directly.

! Note

- Depending on the region, the [LG Smart World], [My Apps] service and [Search] function may not be available.
- The [Search] function does not search content in every online services. It works only in certain online services.

Using the My Apps Menu

You can move or delete an installed application in the [My Apps] menu.

1. Press HOME (⬇️).
2. Select the [My Apps], and press ENTER (⊙).

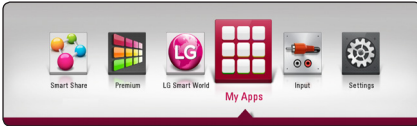

Move an application

1. Select an application, and press green (G) colored button to display the options.
2. Use \wedge / \vee to select [Move], and press ENTER (⊙).
3. Use $\wedge / \vee / < / >$ to select a position you want to move to, and press ENTER (⊙).

Delete an application

1. Select an application, and press green (G) colored button to display the options.
2. Use \wedge / \vee to select [Delete], and press ENTER (⊙).
3. Use $< / >$ to select [Yes], and press ENTER (⊙) to confirm.



Note

Depending on the region, the [LG Smart World], [My Apps] service and [Search] function may not be available.

Troubleshooting

General

Symptom	Cause & Solution
The Power does not turned on.	<ul style="list-style-type: none"> • Plug the power cord into the wall outlet securely.
The unit does not start playback.	<ul style="list-style-type: none"> • Insert a playable disc. (Check the disc type, color system, and regional code.) • Place the disc with the playback side down. • Place the disc on the disc tray correctly inside the guide. • Clean the disc. • Cancel the Rating function or change the rating level.
The connected USB storage device is not recognized.	<ul style="list-style-type: none"> • Try using different USB cable, some USB cables may not support enough current for normal USB operation. • If you use an USB extension cable or USB HUB, the USB devices may not be recognized. • An USB device which requires additional program installation when you have connected it to a computer is not supported. • This unit supports only USB Flash Drive and USB External HDD with FAT32 or NTFS format.
The angle cannot be changed.	<ul style="list-style-type: none"> • Multi-angles are not recorded on the DVD Video being played.
Cannot play video, photo or audio files.	<ul style="list-style-type: none"> • The files are not recorded in a format that the unit can play. • The unit does not support the codec of the video file.
The remote control does not work properly.	<ul style="list-style-type: none"> • The remote control is not pointed at the remote sensor of the unit. • The remote control is too far from the unit. • There is an obstacle in the path of the remote control and the unit. • The batteries in the remote control are exhausted.
The unit is plugged in, but the power will not turn on or off.	<p>You can reset the unit as follows.</p> <ul style="list-style-type: none"> • Unplug the power cord, wait at least five seconds, and then plug it in again.
The unit is not operating normally.	

Network

Symptom	Cause & Solution
BD-Live feature does not work.	<ul style="list-style-type: none"> The connected USB storage may not have enough space. Connect the USB storage with at least 1GB free space. Ensure that the unit is correctly connected to the local area network and can access the internet (page 19). Your broadband speed may not fast enough to use the BD-Live features. Contact your Internet Service Provider (ISP) and increase the broadband speed is recommended. The [BD-LIVE connection] option in the [Settings] menu is set to [Prohibited]. Set the option to [Permitted].
Streaming video services (such as YouTube™, etc.) are often stopped or “buffer” during playback.	<ul style="list-style-type: none"> Your broadband service speed may not be fast enough to stream video services. Contact your Internet Service Provider (ISP) and increase the broadband speed is recommended.
Media servers are not displayed on the device list.	<ul style="list-style-type: none"> The firewall or anti-virus software on your media server is running. Turn off the firewall or anti-virus software running on your media server. The player is not connected to the local area network that your media server is connected.
Cannot connect the player to the access point or wireless LAN router.	<ul style="list-style-type: none"> The wireless communication may be interrupted from household devices that are using radio frequencies. Move the player away from them.
Access point is not displayed on the “Access point name” list.	<ul style="list-style-type: none"> The access point or wireless LAN router may not broadcast its SSID. Set your access point to broadcast its SSID through your computer. Your network device such as access point may not set with available frequency range and channel that this player can support. Try setting the frequency range and channel on the network device setting.

Picture

Symptom	Cause & Solution
There is no picture.	<ul style="list-style-type: none"> • Select the appropriate video input mode on the TV so the picture from the unit appears on the TV screen. • Connect the video connection securely. • Check the [HDMI Color Setting] in the [Settings] menu is set to the appropriate item that conforms to your video connection. • Your TV may not support the resolution you have set on the player. Change the resolution that your TV accepts. • The player's HDMI OUT jack is connected to a DVI device that does not support copyright protection.
Picture noise appears	<ul style="list-style-type: none"> • You are playing a disc recorded in a colour system that is different from your TV. • Set the resolution which your TV accepts.
Blu-ray 3D disc playback does not output 3D views.	<ul style="list-style-type: none"> • Connect the player to your TV with HDMI cable (Type A, High Speed HDMI™ Cable). • Your TV may not support "HDMI 3D mandatory format". • The [3D Mode] option in the [Settings] menu is set to [Off]. Set the option to [On].

Sound

Symptom	Cause & Solution
There is no sound or the sound is distorted.	<ul style="list-style-type: none"> • The unit is in scan, slow motion, or pause mode. • The sound volume is low. • Check the speaker cable connection. (page 13)

Customer Support

You can update the Player using the latest software to enhance the products operation and/or add new features. To obtain the latest software for this player (if updates have been made), please visit <http://www.lg.com/global/support> or contact LG Electronics customer care center.

Open Source Software Notice

To obtain the corresponding source code under GPL, LGPL and other open source licenses, please visit <http://opensource.lge.com>. All referred license terms, warranty disclaimers and copyright notices are available to download with the source code.

Controlling a TV with the Supplied Remote Control

You can control your TV using the buttons below.

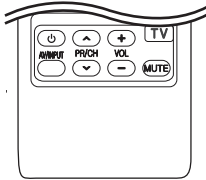

By pressing	You can
⏻ (TV POWER)	Turn the TV on or off.
AV/INPUT	Switch the TV's input source between the TV and other input sources.
PR/CH ▲/▼	Scan up or down through memorized channels.
VOL +/-	Adjust the volume of the TV.
MUTE	Turn the TV's volume on or off.

! Note

Depending on the unit being connected, you may not be able to control your TV using some of the buttons.

Setting up the remote to control your TV

You can operate your TV with the supplied remote control.

If your TV is listed in the table below, set the appropriate manufacturer code.

1. While holding down ⏻ (TV POWER) button, and press the manufacturer code for your TV with the numerical buttons (see the table below).

Manufacturer	Code number
LG	1(Default), 2
Zenith	1, 3, 4
GoldStar	1, 2
Samsung	6, 7
Sony	8, 9
Hitachi	4

2. Release the ⏻ (TV POWER) button to complete setting.

Depending on your TV, some or all buttons may not function on the TV, even after entering the correct manufacturer code. When you replace the batteries of the remote, the code number you have set may be reset to the default setting. Set the appropriate code number again.

Network Software Update

Network update notification

From time to time, performance improvements and/or additional features or services may be made available to units that are connected to a broadband home network. If there is new software available and the unit is connected to a broadband home network, the player will inform you about the update as follows.

Option 1:

1. The update menu will appear on the screen when you turn off the player.
2. Use $\langle \rangle$ to select a desired option and then press ENTER (⊙).

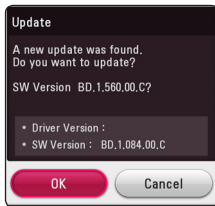

[OK]	Starts the software update.
[Cancel]	Exits the update menu and turns the power off.

Option 2:

If the software update is available from the update server, the "Update" icon appears in the Home menu. Press blue (B) colored button to start the update procedure.

Software update

You can update the player using the latest software to enhance the products operation and/or add new features. You can update the software by connecting the unit directly to the software update server.

! Note

- Before updating the software in your player, remove any disc and USB Device from the player.
- Before updating the software in your player, turn the player off and then turn it back on.
- **During the software update procedure, do not turn off the player or disconnect AC power, or do not press any button.**
- If you cancel the update, turn off the power and turn it on for stable performance.
- This unit cannot be updated to previous software version.

1. Check the network connection and settings (page 19).
2. Select [Software] option in the [Settings] menu then press ENTER (⊙).
3. Select [Update] option, and press ENTER (⊙).



The player will check for the newest update.

! Note

- Pressing ENTER (⊙) while checking for the update will end the process.
- If there is no update available, the Message, "No update is found." appears. Press ENTER (⊙) to return to the [Home Menu].

4. If newer version exists, the message "Do you want to download it?" appears.
5. Select [OK] to start update. (Selecting [Cancel] will end the update.)
6. The player starts downloading the newest update from the server. (Downloading will take several minutes depending on your home network condition)
7. When downloading is completed, the message, "Download is complete. Do you want to update?" appears.
8. Select [OK] to start updating. (Selecting [Cancel] will end the update and downloaded file will not be re-usable. To update software the next time, the software update procedure has to be started from the beginning again.)



Caution

Do not turn off the power during the software update.



Note

If the software includes the driver update, disc tray may open during the process.

9. When update is completed, the power will be turned off automatically in a few seconds.
10. Turn the power back on. The system now operates with the new version.



Note

The Software Update function may not work properly depending on your internet environment. In this case, you can obtain the latest software from the authorized LG Electronics Service Center then update your player. Refer to "Customer Support" on page 63.

Additional Information

File requirement

Video files

File Location	File Extension	Codec Format	Audio Format	Subtitle
Disc, USB	“.avi”, “.mpg”, “.mpeg”, “.mkv”, “.mp4”, “.asf”, “.wmv”, “.m4v” (DRM free), “.vob”, “.3gp”, “.mov”, “.trp”, “.m2t”, “.mpe”, “.m1v”, “.m2v”, “.wm”, “.flv”, “.ts”, “.dat”	XVID, MPEG1 SS, H.264/MPEG-4 AVC, MPEG2 PS, MPEG2 TS, VC-1 SM (WMV3)	Dolby Digital, DTS, MP3, WMA, AAC, AC3	SubRip (.srt / .txt), SAMI (.smi), SubStation Alpha (.ssa/.txt), MicroDVD (.sub/.txt), VobSub (.sub), SubViewer 1.0 (.sub), SubViewer 2.0 (.sub/.txt), TMPlayer (.txt), DVD Subtitle System (.txt)
DLNA	“.avi”, “.mpg”, “.mpeg”, “.mkv”, “.mp4”, “.asf”, “.wmv”, “.m4v” (DRM free), “.mov”, “.trp”, “.m2t”, “.mpe”, “.m1v”, “.m2v”, “.flv”, “.ts”	XVID, MPEG1 SS, H.264/MPEG-4 AVC, MPEG2 PS, MPEG2 TS, VC-1 SM (WMV3)	Dolby Digital, DTS, MP3, WMA, AAC, AC3	SubRip (.srt / .txt), SAMI (.smi), SubStation Alpha (.ssa/.txt), MicroDVD (.sub/.txt), SubViewer 1.0 (.sub), SubViewer 2.0 (.sub/.txt), TMPlayer (.txt), DVD Subtitle System (.txt)

Audio files

File Location	File Extension	Sampling Frequency	Bitrate	Note
Disc, USB	“.mp3”, “.wma”, “.wav”, “.m4a” (DRM free), “.flac”	within 32 - 48 kHz (WMA), within 16 - 48 kHz (MP3)	within 32 - 192 kbps (WMA), within 32 - 320 kbps (MP3)	Some wav files are not supported on this player.
DLNA	“.mp3”, “.wma”, “.wav”, “.m4a” (DRM free)	within 32 - 48 kHz (WMA), within 16 - 48 kHz (MP3)	within 32 - 192 kbps (WMA), within 32 - 320 kbps (MP3)	Some wav files are not supported on this player.

Photo files

File Location	File Extension	Recommended Size	Note
Disc, USB, DLNA	“.jpg”, “.jpeg”, “.png”, “.gif”	Less than 4,000 x 3,000 x 24 bit/pixel Less than 3,000 x 3,000 x 32 bit/pixel	Progressive and lossless compression photo image files are not supported.

- Supplied bundle DLNA server for Macintosh edition has limitations in file compatibility, such as ASF, WMA and WMV.

Note

- The file name is limited to 180 characters.
- Maximum files/Folder: Less than 2000 (total number of files and folders)
- Depending on the size and number of the files, it may take several minutes to read the content on the media.
- File compatibility may differ depending on the server.
- Because the compatibility on DLNA server are tested on the bundle DLNA server (Nero MediaHome 4 Essentials Windows edition) environment, file requirements and playback functions may differ depending on media servers.
- The file requirements on page 67 are not always compatible. There may have some restrictions by file features and media server's ability.
- Playing video subtitle files are only available on DLNA media server created by supplied Nero MediaHome 4 Essentials software on this player package.
- The files from removable media such as USB drive, DVD-drive etc. on your media server may not be shared properly.
- This unit cannot support the ID3 Tag embedded MP3 file.
- The total playback time of audio file indicated on the screen may not correct for VBR files.
- HD video files contained on the CD/DVD or USB 1.0/1.1 may not played properly. Blu-ray Disc or USB 2.0 are recommended to play back HD video files.
- This player supports H.264/MPEG-4 AVC profile Main, High at Level 4.1. A file with higher level may not be supported.
- This player does not support files that are recorded with GMC*¹ or Qpel*².
 - *1 GMC – Global Motion Compensation
 - *2 Qpel – Quarter pixel

Note

- A "avi" file which is encoded "WMV 9 codec" is not supported.
- This player supports UTF-8 files even it contains Unicode subtitle content. This player can not support the pure Unicode subtitle files.
- Depending on the types of file or ways of recording, it may not play back.
- A disc which was recorded by multi-session on normal PC is not supported on this player.
- To be playback a video file, video file name and Subtitle file name must be the same.
- When you play a video file with a extension such as ".ts", ".m2ts", ".mts", ".tp", ".Trp" or ".m2t", your player may not support subtitle files.
- The total playback time of audio file indicated on the screen may not correct for VBR files.
- Video / Audio codec compatibility may differ depending on video file.

AVCHD (Advanced Video Codec High Definition)

- This player can playback AVCHD format discs. These discs are normally recorded and used in camcorders.
- The AVCHD format is a high definition digital video camera format.
- The MPEG-4 AVC/H.264 format is capable of compressing images at higher efficiency than that of the conventional image compressing format.
- This player can playback AVCHD discs using "x.v.Color" format.
- Some AVCHD format discs may not play depending on the recording condition.
- AVCHD format discs need to be finalized.
- "x.v.Color" offers a wider color range than normal DVD camcorder discs.

About DLNA

This Player is a DLNA Certified digital media player that can display and play video, photo and audio content from your DLNA-compatible digital media server (PC and Consumer Electronics).

The Digital Living Network Alliance (DLNA) is a cross-industry organization of consumer electronics, computing industry and mobile device companies. Digital Living provides consumers with easy sharing of digital media through your home network.

The DLNA certification logo makes it easy to find products that comply with the DLNA Interoperability Guidelines. This unit complies with DLNA Interoperability Guidelines v1.5.

When a PC running DLNA server software or other DLNA compatible device is connected to this player, some setting changes of software or other devices may be required. Please refer to the operating instructions for the software or device for more information.

Certain system requirements

For high definition video playback:

- High definition display that has HDMI input jack.
- BD-ROM disc with high definition content.
- HDMI or HDCP capable DVI input on your display device is required for some content (as specified by disc authors).

Compatibility notes

- Because BD-ROM is a new format, certain disc, digital connection and other compatibility issues are possible. If you experience compatibility problems, please contact an authorized Customer Service Center.
- This unit allows you to enjoy functions such as picture-in-picture, secondary audio and Virtual packages, etc., with BD-ROM supporting BONUSVIEW (BD-ROM version 2 Profile 1 version 1.1). Secondary video and audio can be played from a disc compatible with the picture-in-picture function. For the playback method, refer to the instructions in the disc.
- Viewing high-definition content and up-converting standard DVD content may require a HDMI-capable input or HDCP-capable DVI input on your display device.
- Some BD-ROM and DVD discs may restrict the use of some operation commands or features.
- Dolby TrueHD, Dolby Digital Plus and DTS-HD are supported with maximum 5.1 channels if you use HDMI connection for the audio output of the unit.
- You can use an USB device to store some disc related information, including downloaded online content. The disc you are using will control how long this information is retained.

Audio Output Specifications

Jack/Setting Source	HDMI OUT			
	PCM Stereo	PCM Multi-Ch	DTS Re-encode *3	Bit Stream *1*2
Dolby Digital	PCM 2ch	PCM 5.1ch	DTS	Dolby Digital
Dolby Digital Plus	PCM 2ch	PCM 5.1ch	DTS	Dolby Digital Plus
Dolby TrueHD	PCM 2ch	PCM 5.1ch	DTS	Dolby TrueHD
DTS	PCM 2ch	PCM 5.1ch	DTS	DTS
DTS-HD	PCM 2ch	PCM 5.1ch	DTS	DTS-HD
Linear PCM 2ch	PCM 2ch	PCM 2ch	DTS	Linear PCM 2ch
Linear PCM 5.1ch	PCM 2ch	PCM 5.1ch	DTS	Linear PCM 5.1ch
Linear PCM 7.1ch	PCM 2ch	PCM 5.1ch	DTS	Linear PCM 7.1ch

*1 The secondary and interactive audio may not be included in the output bitstream if [Digital Output] option is set to [Bit Stream]. (Except LPCM Codec : the output always include interactive and secondary audio.)

*2 This player automatically selects the HDMI audio according to the decoding capability of the connected HDMI device even though [Digital Output] option is set to [Bit Stream].

*3 If the [Digital Output] option is set to [DTS re-encode], the audio output is limited to 48 kHz and 5.1Ch. If the [Digital Output] option is set to [DTS re-encode], the DTS Re-encode audio is outputted for BD-ROM discs, and the original audio is outputted for the other discs (like [Bit Stream]).

- The audio is outputted as PCM 48 kHz/16 bit for MP3/WMA file and PCM 44.1kHz/16 bit for Audio CD while playback.
- With digital audio connection (HDMI OUT), Disc Menu button sounds of BD-ROM may not be heard if the [Digital Output] option is set to [Bit Stream].
- If the audio format of the digital output does not match the capabilities of your receiver, the receiver will produce a strong, distorted sound or no sound at all.
- Multi-channel Digital Surround Sound via digital connection can only be obtained if your receiver is equipped with a Digital Multi-channel decoder.
- This setting is not available on the input signal from an external device.

Area Code List

Choose an area code from this list.

Area	Code	Area	Code	Area	Code	Area	Code
Afghanistan	AF	Fiji	FJ	Monaco	MC	Singapore	SG
Argentina	AR	Finland	FI	Mongolia	MN	Slovak Republic	SK
Australia	AU	France	FR	Morocco	MA	Slovenia	SI
Austria	AT	Germany	DE	Nepal	NP	South Africa	ZA
Belgium	BE	Great Britain	GB	Netherlands	NL	South Korea	KR
Bhutan	BT	Greece	GR	Antilles	AN	Spain	ES
Bolivia	BO	Greenland	GL	New Zealand	NZ	Sri Lanka	LK
Brazil	BR	Hong Kong	HK	Nigeria	NG	Sweden	SE
Cambodia	KH	Hungary	HU	Norway	NO	Switzerland	CH
Canada	CA	India	IN	Oman	OM	Taiwan	TW
Chile	CL	Indonesia	ID	Pakistan	PK	Thailand	TH
China	CN	Israel	IL	Panama	PA	Turkey	TR
Colombia	CO	Italy	IT	Paraguay	PY	Uganda	UG
Congo	CG	Jamaica	JM	Philippines	PH	Ukraine	UA
Costa Rica	CR	Japan	JP	Poland	PL	United States	US
Croatia	HR	Kenya	KE	Portugal	PT	Uruguay	UY
Czech Republic	CZ	Kuwait	KW	Romania	RO	Uzbekistan	UZ
Denmark	DK	Libya	LY	Russian Federation	RU	Vietnam	VN
Ecuador	EC	Luxembourg	LU	Saudi Arabia	SA	Zimbabwe	ZW
Egypt	EG	Malaysia	MY	Senegal	SN		
El Salvador	SV	Maldives	MV				
Ethiopia	ET	Mexico	MX				

Language Code List

Use this list to input your desired language for the following initial settings: [Disc Audio], [Disc Subtitle] and [Disc Menu].

Language	Code	Language	Code	Language	Code	Language	Code
Afar	6565	French	7082	Lithuanian	7684	Sindhi	8368
Afrikaans	6570	Frisian	7089	Macedonian	7775	Singhalese	8373
Albanian	8381	Galician	7176	Malagasy	7771	Slovak	8375
Amharic	6577	Georgian	7565	Malay	7783	Slovenian	8376
Arabic	6582	German	6869	Malayalam	7776	Spanish	6983
Armenian	7289	Greek	6976	Maori	7773	Sudanese	8385
Assamese	6583	Greenlandic	7576	Marathi	7782	Swahili	8387
Aymara	6588	Guarani	7178	Moldavian	7779	Swedish	8386
Azerbaijani	6590	Gujarati	7185	Mongolian	7778	Tagalog	8476
Bashkir	6665	Hausa	7265	Nauru	7865	Tajik	8471
Basque	6985	Hebrew	7387	Nepali	7869	Tamil	8465
Bengali; Bangla	6678	Hindi	7273	Norwegian	7879	Telugu	8469
Bhutani	6890	Hungarian	7285	Oriya	7982	Thai	8472
Bihari	6672	Icelandic	7383	Panjabi	8065	Tonga	8479
Breton	6682	Indonesian	7378	Pashto, Pushto	8083	Turkish	8482
Bulgarian	6671	Interlingua	7365	Persian	7065	Turkmen	8475
Burmese	7789	Irish	7165	Polish	8076	Twi	8487
Byelorussian	6669	Italian	7384	Portuguese	8084	Ukrainian	8575
Chinese	9072	Japanese	7465	Quechua	8185	Urdu	8582
Croatian	7282	Kannada	7578	Rhaeto-Romance	8277	Uzbek	8590
Czech	6783	Kashmiri	7583	Rumanian	8279	Vietnamese	8673
Danish	6865	Kazakh	7575	Russian	8285	Volapük	8679
Dutch	7876	Kirghiz	7589	Samoan	8377	Welsh	6789
English	6978	Korean	7579	Sanskrit	8365	Wolof	8779
Esperanto	6979	Kurdish	7585	Scots Gaelic	7168	Xhosa	8872
Estonian	6984	Laotian	7679	Serbian	8382	Yiddish	7473
Faroese	7079	Latin	7665	Serbo-Croatian	8372	Yoruba	8979
Fiji	7074	Latvian, Lettish	7686	Shona	8378	Zulu	9085
Finnish	7073	Lingala	7678				

Trademarks and Licenses



Blu-ray Disc™, Blu-ray™, Blu-ray 3D™, BD-Live™, BONUSVIEW™ and the logos are trademarks of the Blu-ray Disc Association.



“DVD Logo” is a trademark of DVD Format/Logo Licensing Corporation.



Java is a trademark of Oracle and/or its affiliates.



The terms HDMI and HDMI High-Definition Multimedia Interface, and the HDMI logo are trademarks or registered trademarks of HDMI Licensing LLC in the United States and other countries.

“x.v.Color” is a trademark of Sony Corporation.



Manufactured under license from Dolby Laboratories. Dolby and the double-D symbol are trademarks of Dolby Laboratories.



Manufactured under license under U.S. Patent Nos: 5,956,674; 5,974,380; 6,226,616; 6,487,535; 7,392,195; 7,272,567; 7,333,929; 7,212,872 & other U.S. and worldwide patents issued & pending. DTS-HD, the Symbol, & DTS-HD and the Symbol together are registered trademarks & DTS-HD Master Audio | Essential is a trademark of DTS, Inc. Product includes software. © DTS, Inc. All Rights Reserved.



DLNA®, the DLNA Logo and DLNA CERTIFIED® are trademarks, service marks, or certification marks of the Digital Living Network Alliance.



The Wi-Fi CERTIFIED Logo is a certification mark of the Wi-Fi Alliance.



The Wi-Fi Protected Setup Mark is a trademark of the Wi-Fi Alliance.



“AVCHD” and the “AVCHD” logo are trademarks of Panasonic Corporation and Sony Corporation.



"Made for iPod," "Made for iPhone," and "Made for iPad" mean that an electronic accessory has been designed to connect specifically to iPod, iPhone, or iPad, respectively, and has been certified by the developer to meet Apple performance standards. Apple is not responsible for the operation of this device or its compliance with safety and regulatory standards. Please note that the use of this accessory with iPod, iPhone, or iPad may affect wireless performance.



Bluetooth® wireless technology is a system which allows radio contact between electronic devices within a max. range of 10 meters.

Connecting individual devices under *Bluetooth*® wireless technology does not incur any charges. A mobile phone with *Bluetooth*® wireless technology can be operated via the Cascade if the connection was made via *Bluetooth*® wireless technology.

The *Bluetooth*® word mark and logos are owned by the *Bluetooth*® SIG, Inc. and any use of such marks by LG Electronics is under license.

Other trademarks and trade names are those of their respective owners.

Cinavia Notice

This product uses Cinavia technology to limit the use of unauthorized copies of some commercially-produced film and videos and their soundtracks. When a prohibited use of an unauthorized copy is detected, a message will be displayed and playback or copying will be interrupted.

More information about Cinavia technology is provided at the Cinavia Online Consumer Information Center at <http://www.cinavia.com>. To request additional information about Cinavia by mail, send a postcard with your mailing address to: Cinavia Consumer Information Center, P.O. Box 86851, San Diego, CA, 92138, USA.

This product incorporates proprietary technology under license from Verance Corporation and is protected by U.S. Patent 7,369,677 and other U.S. and worldwide patents issued and pending as well as copyright and trade secret protection for certain aspects of such technology. Cinavia is a trademark of Verance Corporation. Copyright 2004-2012 Verance Corporation. All rights reserved by Verance. Reverse engineering or disassembly is prohibited.



Gracenote®, Gracenote logo and logotype, and the “Powered by Gracenote” logo are either registered trademarks or trademarks of Gracenote, Inc. in the United States and/or other countries.

Music recognition technology and related data are provided by Gracenote®.

Portions of the content is copyright © Gracenote or its providers.

Gracenote® End User License Agreement

This application or device contains software from Gracenote, Inc. of Emeryville, California (“Gracenote”). The software from Gracenote (the “Gracenote Software”) enables this application to perform disc and/or file identification and obtain music-related information, including name, artist, track, and title information (“Gracenote Data”) from online servers or embedded databases (collectively, “Gracenote Servers”) and to perform other functions. You may use Gracenote Data only by means of the intended End-User functions of this application or device.

You agree that you will use Gracenote Data, the Gracenote Software, and Gracenote Servers for your own personal non-commercial use only. You agree not to assign, copy, transfer or transmit the Gracenote Software or any Gracenote Data to any third party. YOU AGREE NOT TO USE OR EXPLOIT GRACENOTE DATA, THE GRACENOTE SOFTWARE, OR GRACENOTE SERVERS, EXCEPT AS EXPRESSLY PERMITTED HEREIN.

You agree that your non-exclusive license to use the Gracenote Data, the Gracenote Software, and Gracenote Servers will terminate if you violate these restrictions. If your license terminates, you agree to cease any and all use of the Gracenote Data, the Gracenote Software, and Gracenote Servers. Gracenote reserves all rights in Gracenote Data, the Gracenote Software, and the Gracenote Servers, including all ownership rights. Under no circumstances will Gracenote become liable for any payment to you for any information that you provide. You agree that Gracenote, Inc. may enforce its rights under this Agreement against you directly in its own name.

The Gracenote service uses a unique identifier to track queries for statistical purposes. The purpose of a randomly assigned numeric identifier is to allow the Gracenote service to count queries without knowing anything about who you are. For more information, see the web page for the Gracenote Privacy Policy for the Gracenote service.

The Gracenote Software and each item of Gracenote Data are licensed to you “AS IS.” Gracenote makes no representations or warranties, express or implied, regarding the accuracy of any Gracenote Data from in the Gracenote Servers. Gracenote reserves the right to delete data from the Gracenote Servers or to change data categories for any cause that Gracenote deems sufficient. No warranty is made that the Gracenote Software or Gracenote Servers are error-free or that functioning of Gracenote Software or Gracenote Servers will be uninterrupted. Gracenote is not obligated to provide you with new enhanced or additional data types or categories that Gracenote may provide in the future and is free to discontinue its services at any time.

GRACENOTE DISCLAIMS ALL WARRANTIES EXPRESS OR IMPLIED, INCLUDING, BUT NOT LIMITED TO, IMPLIED WARRANTIES OF MERCHANTABILITY, FITNESS FOR A PARTICULAR PURPOSE, TITLE, AND NON-INFRINGEMENT. GRACENOTE DOES NOT WARRANT THE RESULTS THAT WILL BE OBTAINED BY YOUR USE OF THE GRACENOTE SOFTWARE OR ANY GRACENOTE SERVER. IN NO CASE WILL GRACENOTE BE LIABLE FOR ANY CONSEQUENTIAL OR INCIDENTAL DAMAGES OR FOR ANY LOST PROFITS OR LOST REVENUES.

© Gracenote, Inc. 2009

Specifications

General	
Power requirements	Refer to main label
Power consumption	Refer to main label
Dimensions (W x H x D)	Approx. 360 mm x 60.5 mm x 299 mm (14.1 inches x 2.3 inches x 11.7 inches)
Net Weight (Approx.)	2.7 kg (5.9 lbs)
Operating temperature	5 °C to 35 °C (41 °F to 95 °F)
Operating humidity	5 % to 90 %

Inputs/Outputs	
HDMI OUT (video/audio)	19 pin (Type A, HDMI™ Connector) x 1
ANALOG AUDIO IN	2.0 Vrms (1 kHz, 0 dB), 600 Ω, RCA jack (L, R) x 1
DIGITAL IN (OPTICAL)	3 V (p-p), Optical jack x 1
PORT. IN	0.5 Vrms (3.5 mm stereo jack) x 1

Tuner	
FM Tuning Range	87.5 to 108.0 MHz or 87.50 to 108.00 MHz

Amplifier	
Power output (3 Ω), (RMS), THD 10 %	
Total	1000 W
Front	167 W x 2
Center	167 W
Rear	167 W x 2
Sub-Woofer	167 W (Passive)

System	
Laser	Semiconductor laser
Wavelength	405 nm / 650 nm
Signal system	Standard NTSC color TV system
Frequency response	20 Hz to 18 kHz (48 kHz, 96 kHz, 192 kHz sampling)
Harmonic distortion	Less than 0.05 %
Dynamic range	More than 80 dB
LAN port	Ethernet jack x 1, 10BASE-T / 100BASE-TX
Wireless LAN (internal antenna)	IEEE 802.11b/g/n (2.4 GHz band)
Bus Power Supply (USB)	DC 5 V  2.1 A

Speakers			
Front speaker (Left/ Right)			
Type	1 Way 1 speaker	Max. Input power	334 W
Impedance Rated	3 Ω	Net Dimensions (W x H x D)	97 mm x 140 mm x 80 mm (3.8 inches x 5.5 inches x 3.1 inches)
Input Power	167 W	Net Weight	0.5 kg (1.1 lbs)
Rear speaker (Left/ Right)			
Type	1 Way 1 speaker	Max. Input power	334 W
Impedance Rated	3 Ω	Net Dimensions (W x H x D)	97 mm x 140 mm x 80 mm (3.8 inches x 5.5 inches x 3.1 inches)
Input Power	167 W	Net Weight	0.5 kg (1.1 lbs)
Center speaker			
Type	1 Way 1 speaker	Max. Input power	334 W
Impedance Rated	3 Ω	Net Dimensions (W x H x D)	260 mm x 92 mm x 73 mm (10.2 inches x 3.6 inches x 2.8 inches)
Input Power	167 W	Net Weight	0.65 kg (1.4 lbs)
Subwoofer			
Type	1 Way 1 speaker	Max. Input power	334 W
Impedance Rated	3 Ω	Net Dimensions (W x H x D)	133 mm x 352 mm x 325 mm (5.2 inches x 13.8 inches x 12.7 inches)
Input Power	167 W	Net Weight	5.2 kg (11.4 lbs)

- Design and specifications are subject to change without notice.

Maintenance

Handling the unit

When shipping the unit

Please save the original shipping carton and packing materials. If you need to ship the unit, for maximum protection, re-pack the unit as it was originally packed at the factory.

Cleaning the unit

To clean the player, use a soft, dry cloth. If the surfaces are extremely dirty, use a soft cloth lightly moistened with a mild detergent solution. Do not use strong solvents such as alcohol, benzine, or thinner, as these might damage the surface of the unit.

Keeping the exterior surfaces clean

- Do not use volatile liquids such as insecticide spray near the unit.
- Wiping with strong pressure may damage the surface.
- Do not leave rubber or plastic products in contact with the unit for a long period of time.

Maintaining the unit

The unit is a high-tech, precision device. If the optical pick-up lens and disc drive parts are dirty or worn, the picture quality could be diminished. For details, please contact your nearest authorized service center.

Notes on discs

Handling discs

Do not touch the playback side of the disc. Hold the disc by the edges so that fingerprints do not get on the surface. Never stick paper or tape on the disc.

Storing discs

After playing, store the disc in its case. Do not expose the disc to direct sunlight or sources of heat and never leave it in a parked car exposed to direct sunlight.

Cleaning discs

Fingerprints and dust on the disc can cause poor picture quality and sound distortion. Before playing, clean the disc with a clean cloth. Wipe the disc from the center to out.

Do not use strong solvents such as alcohol, benzine, thinner, commercially available cleaners, or anti-static spray intended for older vinyl records.

Important Information relating to Network Services

All information, data, documents, communications, downloads, files, text, images, photographs, graphics, videos, webcasts, publications, tools, resources, software, code, programs, applets, widgets, applications, products and other content ("Content") and all services and offerings ("Services") provided or made available by or through any third party (each a "Service Provider") is the sole responsibility of the Service Provider from whom it originated.

The availability of and access to Content and Services furnished by the Service Provider through the LGE Device are subject to change at any time, without prior notice, including, but not limited to the suspension, removal or cessation of all or any part of the Content or Services.

Should you have any inquiry or problem related to the Content or Services, you may refer to the Service Provider's website for the most up-to-date information. LGE is neither responsible nor liable for customer service related to the Content and Services. Any question or request for service relating to the Content or Services should be made directly to the respective Content and Service Providers.

Please note that LGE is not responsible for any Content or Services provided by the Service Provider or any changes to, removal of, or cessation of such Content or Services and does not warrant or guaranty the availability of or access to such Content or Services.

